



Owners Manual

International



engineered for the world's harshest climates®



Congratulations!



Your choice of an Arctic Spa indicates that you are devoted to excellence. At Arctic Spas® we believe a good foundation is required to build a superior product, both in design and philosophy. Canadian built with the finest materials and advanced technology to withstand even the harshest of weather conditions, Arctic Spas® are made to perform... wherever you happen to live. To safely and effectively use your spa, we recommend that you take the time to read this manual before you hook-up and operate the spa. This guide will acquaint you with the operating features, hook-up procedures, and the maintenance and safety procedures, ensuring an enjoyable experience right from the start.

If you require additional information, please call your local Arctic Spas® dealer. A complete list of dealers and international Arctic Spas websites can be found on the internet at ArcticSpas.com.

IMPORTANT!

In most cities and counties, permits will be required for the installation of electrical circuits or the construction of exterior surfaces (decks and gazebos). In addition, some communities have adopted residential barrier codes which may require fencing and/or self-closing gates on the property to prevent unsupervised access to a pool or spa by children under 5 years of age. Your Arctic Spa is equipped with a locking cover that meets the ASTM F1346-91 Standard for Safety Covers and as a result, is usually exempt from most barrier requirements. As a general practice, your local Building Department will inform you of any applicable barrier requirements at the time a permit is obtained for the installation of an electrical circuit. Your Arctic Spas Dealer can provide information on which permits may be required.

IMPORTANT SAFETY INFORMATION

This appliance is not intended for use by persons (including children) with reduced physical, sensory or mental capabilities, or lack of experience and knowledge, unless they have been given supervision or instruction concerning use of the appliance by a person responsible for their safety.

Children should be supervised to ensure that they do not play with the appliance.

Cleaning and user maintenance shall not be made by children without supervision.

Contents

Owners Manual - Expedition Class	1
Important Safety Instruction	5
Hyperthermia	7
Spa Specifications	8
Installation Instructions	9
Electrical Specifications	10
Electrical Installation Instructions	10
Startup Procedures	11
Spa Overview	13
Jets	14
Topside Control Panel	15
Quick Reference Guide	16
Spa Care and Maintenance	18
LED Replacement	21
Performing Software Upgrade	22
Troubleshooting Spa Problems	23
Water Maintenance	24
Common Spa Water Problems ~ Cause & Remedy	29
Warranty	31
OnSpa and Web Connect User Guide	33
OnSpa and Web Connect User Guide	33
Arctic Spas App?	34
Downloading the App	34
What is OnSpa?	34
What is Web Connect?	34
What are The Benefits of Web Connect?	35
What is Ethernet Over Power?	35
What is WIFI Extender?	35
What is a Home Network Connection Through LAN Cable?	35
What is myarcticspa.com?	35
How Does onSpa and Web Connect Work?	36
OnSpa Interface Through EoP	36
OnSpa Interface Through WIFI Extender	37
OnSpa Interface Through LAN Cable	37
Web Connect Interface Through EoP	38
Web Connect Interface Through WIFI Extender	38
Web Connect Interface Through LAN Cable	39
OnSpa Quick Reference Charts (QRC)	40
OnSpa QRC Through Ethernet Over Power (EoP) Flowchart	40
OnSpa QRC Through WIFI Extender Flowchart	41
OnSpa QRC Through LAN Cable Flowchart	42
Connect your Spa to the Home Network	42
Low Level Programming Overview	43
How to Connect Your Spa to the My Arctic Spas Server (Web Connect)	44
Web Connect Flowchart	45
Register Spa With My Arctic Spa	46
My Arctic Spa	46
Home Page	47
New User Registration	47
Login First Time	48
Register an Arctic Spa	49
Login	50

My Arctic Spa	50
Settings	51
Documentation	52
Error Codes	52
About	52
Profile	53
Diagnostics	53
Logout	53
Spa Boy Owners Manual.....	54
Spa Boy Owners Manual	54
Obtaining Technical Data For Your Spa.....	54
Revision Summary	54
What is Spa Boy?.....	54
What Does Spa Boy Do?	54
What Are The Benefits of Spa Boy?.....	54
How Does Spa Boy Work?.....	55
Spa Boy System Interface.....	55
Spa Boy Main Components	56
Spa Boy Version Summary	57
Spa Boy Version Table.....	57
Spa Boy Version – Installed in Owners Spa	57
How to Determine Spa Production Date	57
Definitions of Terms	58
Water Chemistry Abbreviations/Acronyms & Ranges	62
Spa Boy Warranty	62
Spa Boy Start – Up Guide	63
Spa Boy Start-Up Overview Flowchart.....	63
Fill Spa With Water Power Up Spa and Set Water Temperature	64
Program Filtration Cycles/Filtration Duration.....	65
Stabilize Spa Water	65
Establishing Correct Water Chemistry	66
Arctic Spas Spa Boy Salt Dose Guidance Table.....	69
Sanitizer and pH Readings.....	69
Caring for your Spa Boy System.....	70
Arctic Spas Spa Boy Version 1 R1 Maintenance Schedule	77
Troubleshooting Spa Boy Low ORP Reading Detected.....	79
Onzen Owners Manual.....	81
Onzen Technical Guide	81
Obtaining Technical Data For Your Spa.....	81
Revision Summary	81
What is Onzen?.....	81
What Does Onzen Do?	81
What Are The Benefits of Onzen?.....	81
How Does Onzen Work?.....	81
How to Determine Spa Production Date	81
Definitions of Terms	82
Water Chemistry Abbreviations/Acronyms & Levels	85
Abbreviations Acronyms & Settings	85
Onzen Start – Up Guide	86
Onzen Start-Up Overview Flowchart.....	86
Fill Spa With Water Power Up Spa and Set Water Temperature	87
Establishing Correct Water Chemistry	88
Arctic Spas Onzen Salt Dose Guidance Table.....	90
Using Sodium Chloride Test Strips	91
Program Filtration & Onzen Settings.....	93
Conducting a Sanitizer Production Test.....	94
Sanitizer Readings	97
Onzen Cloudy Water Troubleshooting Flowchart.....	98

Onzen Frequently Asked Questios.....	99
Arctic Spas Onzen Maintenance Schedule	101
Owners Manual - Bear Essential Class & Core Series.....	103
Spa Specifications.....	103
Overview	103
Keypad Installation	104
Electrical Wiring	105
Heater Connections.....	107
Power-up & breaker setting.....	108
Keypad Overview	110
Error Codes	113
Troubleshooting.....	118
How to Set the Clock, filtration and Essentials Salt.....	128
How to Set Low Level Programming on INYE Pack.....	130
Specifications	131
Important Safety Instructions.....	133
Specifications	133
Features	134
General Product Information	134
Power & No Flow Protection	134
Operation.....	134
Ordering Information	134
Warranty - Bear Essential Class	135
Warranty - Core Series.....	137

OWNERS MANUAL

EXPEDITION CLASS

Important Safety Instructions:

READ AND FOLLOW ALL INSTRUCTIONS CAREFULLY

When installing and using this electrical equipment, basic safety precautions should always be followed, including:

- 1) WARNING:** To reduce the risk of injury, do not permit children to use this product unless they are closely supervised at all times.
- 2) WARNING:** A grounding wire connector is provided on this unit to connect a minimum No. 8 AWG solid copper conductor (USA) No. 6 AWG stranded (Canada) 8.4mm (Europe) between this unit and any metal equipment, metal enclosures of electrical equipment, metal water pipe, or conduit within 5 feet (1.5 m) of the unit.
- 3) DANGER:** Risk of Accidental Drowning. Extreme caution must be exercised to prevent unauthorized access by children. To avoid accidents, ensure that children cannot use this hot tub unless they are supervised at all times. Use the hot tub straps, cover safety and clip tie downs to secure the cover when not in use. This will help to discourage unsupervised children from entering the hot tub. There is no representation that the cover, clip tie downs, or actual locks will prevent access to the hot tub.
- 4) DANGER:** Risk of Injury. The suction fittings in this hot tub are sized to match the specific water flow created by the pump. Should the need arise to replace the suction fittings or the pump, be sure that the flow rates are compatible. Never operate the hot tub if the suction fittings are broken or missing. Consult your local dealer for assistance in choosing an appropriate replacement suction fitting.



IMPORTANT!

This manual was written to ensure the proper use and installation of any Arctic Spa. Any modifications to the procedures outlined may result in your warranty being voided. Please read this manual to avoid any unnecessary damage to your spa and equipment.

5) DANGER: Risk of Electric Shock. Install at least 5 feet (1.5 m), from all metal surfaces. As an alternative, a hot tub may be installed within 5 feet (1.5 m) of metal surfaces if each metal surface is permanently connected (bonded) by a minimum No. 8 AWG solid copper conductor (US) No. 6 AWG stranded (Canada) 8.4 mm (Europe) attached to the wire connector on the equipotential bonding bar which is located on the side of the spa control pack.

6) DANGER: Risk of Electric Shock. Do not permit any electrical appliance, such as a light, telephone, radio, television, etc. within 5 feet (1.5 m) of a hot tub. All controls or devices accessible from the spa must be powered by a maximum of 12vdc. Do not permit any electrical appliances powered by 12 vdc or more within 1.5 m of the hot tub.

7) ELECTRICAL SUPPLY: The electrical supply for this product must include a suitable circuit breaker GFCI (north America) RCD (Europe) to open all ungrounded supply conductors. The disconnect must be readily accessible and visible to the hot tub occupant but installed at least 5 feet (1.5 m), from the hot tub water.

8) WARNING: To Reduce the Risk of Injury:

a) The water in a hot tub should never exceed 104°F (40°C). Water temperatures between 100°F (38°C) and 104°F (40°C) are considered safe for a healthy adult. Lower water temperatures are recommended for young children and when hot tub use exceeds 10 minutes.

b) Since excessive water temperatures have a high potential for causing fetal damage during the early months of pregnancy, pregnant or possibly pregnant women should limit hot tub water temperatures to 100°F (38°C). If pregnant, please consult your physician before using a hot tub.

c) The use of alcohol, drugs, or medication before or during hot tub use may lead to unconsciousness with the possibility of drowning.

OWNERS MANUAL - EXPEDITION CLASS

d) Persons suffering from obesity or a medical history of heart disease, low or high blood pressure, circulatory system problems, or diabetes should consult a physician before using a hot tub.

e) Persons using medication should consult a physician before using a hot tub since some medication may induce drowsiness, while other medication may affect heart rate, blood pressure, and circulation.

9) WARNING: A bonding lug bar is provided on the side of your spa pack to accommodate grounding of entire spa. To reduce the risk of electric shock, connect the local common bonding grid in the area of the hot tub to these terminals with an insulated or bare copper conductor not smaller than No. 8 AWG solid (US) No. 6 AWG stranded (Canada) 8.4 mm (Europe).

SAVE THESE INSTRUCTIONS

WARNINGS!

WARNING: Children should not use hot tubs without adult supervision.

AVERTISSEMENT: Ne pas laisser les enfants utiliser une cuve de relaxation sans surveillance.

WARNING: Do not use hot tubs unless all suction guards are installed to prevent body and hair entrapment.

AVERTISSEMENT: Pour éviter que les cheveux ou une partie du corps puissent être aspirés, ne pas utiliser une cuve de relaxation si des grilles de prise d'aspiration ne sont pas toutes en place.

WARNING: People with infectious diseases should not use a hot tub.

AVERTISSEMENT: Les personnes atteintes de maladies infectieuses ne devraient pas utiliser une cuve de relaxation.

WARNING: To avoid injury, exercise care when entering or exiting the hot tub.

AVERTISSEMENT: Pour éviter des blessures, user de prudent en entrant dans une de cuve de relaxation et en sortant.

WARNING: Do not use drugs or alcohol before or during the use of a hot tub to avoid unconsciousness and possible drowning.

AVERTISSEMENT: Pour éviter l'évanouissement et la noyade éventuelle, ne prendre ni drogue ni alcool avant d'utiliser une cuve de relaxation ni quand on s'y trouve.

WARNING: Pregnant or possibly pregnant women should consult a physician before using a hot tub.

AVERTISSEMENT: Les femmes enceintes, que leur grossesse soit confirmée ou non, devraient consulter un médecin avant d'utiliser la cuve de relaxation.

WARNING: Water temperature in excess of 100°F (38°C) may be injurious to your health.

AVERTISSEMENT: Il peut être dangereux pour la santé de se plonger dans de l'eau à plus de 100°F (38°C).

WARNING: Before entering the hot tub, measure the water temperature with an accurate thermometer.

AVERTISSEMENT: Avant d'utiliser une cuve de relaxation mesurer la température de l'eau à l'aide d'un thermomètre précis.

WARNING: Do not use a hot tub immediately following strenuous exercise.

AVERTISSEMENT: Ne pas utiliser une cuve de relaxation immédiatement après un exercice fatigant.



Read and Follow All Instructions

It is important to inform occasional users of the spa about the **DANGERS, WARNINGS, and CAUTIONS** listed in this manual before they use the spa.

CAUTION!

Indicates a situation in which damage to equipment or material may occur.

DANGER!

Indicates risk of injury.

WARNING!

Indicates information of critical importance.



WARNING: Prolonged immersion in a hot tub may be injurious to your health.

AVERTISSEMENT: L'utilisation prolongée d'une cuve de relaxation peut être dangereuse pour la santé.

WARNING: Do not permit electric appliances (such as light, telephone, radio, television, etc.) within 5 feet (1.5m) of this hot tub.

AVERTISSEMENT: Ne pas placer d'appareil électrique (luminaire, téléphone, radio, téléviseur, etc.) à moins de 5 feet (1.5m) de cette cuve de relaxation.

CAUTION: Maintain water chemistry in accordance with manufacturer's instructions.

ATTENTION: La teneur de l'eau en matières dissoutes doit être conforme aux directives du fabricant.

WARNING: The use of alcohol or drugs can greatly increase the risk of fatal hyperthermia in hot tubs.

AVERTISSEMENT: La consommation d'alcool ou de drogue augmente considérablement les risques d'hyperthermie mortelle dans une cuve de relaxation.

WARNING: People using medications and / or having an adverse medical history should consult a physician before using a spa or hot tub.

AVERTISSEMENT: Les personnes qui prennent des médicaments ou ont des problèmes de santé devraient consulter un médecin avant d'utiliser une cuve de relaxation.

Hyperthermia

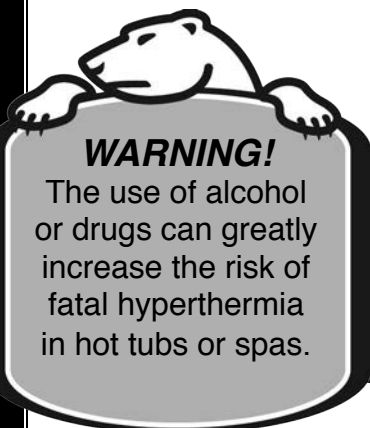

Prolonged immersion in hot water may induce hyperthermia.

Hyperthermia occurs when the internal temperature of the body reaches a level several degrees above the normal body temperature of 99°F (37°C). The symptoms of hyperthermia include drowsiness, lethargy, and an increase in the internal temperature of the body. The effects of hyperthermia include:

- ▶ Unawareness of impending hazard;
- ▶ Failure to perceive heat;
- ▶ Failure to recognize the need to exit hot tub;
- ▶ Physical inability to exit hot tub;
- ▶ Fetal damage in pregnant women; and
- ▶ Unconsciousness and danger of drowning.

SPA SPECIFICATIONS

	Outside Dimensions	Heights	Heater (Watts)	Water Capacity	Dry Weight	Electrical Requirements North America	Electrical Requirements Europe
Athabasca	171.75"x93" 436cm x 236cm	50.5" 128.5 cm	NA / Euro 5500/2x3600	1347 Gallons 5100 Litres	1909 Lbs 866 Kg	240 Volt, 50 Amp	1 phase x 32Amp or 3 phase x 16Amp
Cub	86"x86" 217cm x 217cm	41" 104 cm	NA / Euro 5500/2x3600	313 Gallons 1185 Litres	740 Lbs 336 Kg	240 Volt, 50 Amp	1 phase x 32Amp or 3 phase x 16Amp
Fox	86"x69" 217cm x 174cm	38.75" 98 cm	NA / Euro 5500/2x3600	234 Gallons 884 Litres	611 Lbs 277 Kg	240 Volt, 50 Amp	1 phase x 32Amp or 3 phase x 16Amp
Frontier	86"x93" 217cm x 235cm	38.75" 98 cm	NA / Euro 5500/2x3600	351 Gallons 1330 Litres	785 Lbs 356 Kg	240 Volt, 50 Amp	1Øx32Amp, 3Øx16Amp (Epic series require 1Øx40A, 3Øx-16Amp, 3Øx20Amp, 3Øx25Amp)
Glacier	86"x86" 217cm x 217cm	41" 104 cm	NA / Euro 5500/2x3600	302 Gallons 1144 Litres	827 Lbs 375 Kg	240 Volt, 50 Amp	1 phase x 32Amp or 3 phase x 16Amp
Hudson	171.75"x93" 436cm x 236cm	50.5" 128.5 cm	NA / Euro 5500/2x3600	1347 Gallons 5100 Litres	1909 Lbs 866 Kg	240 Volt, 50 Amp	1 phase x 32Amp or 3 phase x 16Amp
Kingfisher	171.75"x93" 436cm x 236cm	50.5" 128.5 cm	NA / Euro 5500/2x3600	1347 Gallons 5100 Litres	1909 Lbs 866 Kg	240 Volt, 60 Amp	1Øx40Amp, 3Øx16Amp, 3Øx20Amp, 3Øx25Amp
Klondiker	93"x93" 235cm x 235cm	38.75" 98 cm	NA / Euro 5500/2x3600	378 Gallons 1431 Litres	944 Lbs 428 Kg	240 Volt, 50 Amp (Epic series require 60amp)	1Øx32Amp, 3Øx16Amp (Epic series require 1Øx40A, 3Øx-16Amp, 3Øx20Amp, 3Øx25Amp)
Kodiak	93"x93" 235cm x 235cm	38.75" 98 cm	NA / Euro 5500/2x3600	370 Gallons 1400 Litres	972 Lbs 441 Kg	240 Volt, 50 Amp (Epic series require 60amp)	1Øx32Amp, 3Øx16Amp (Epic series require 1Øx40A, 3Øx-16Amp, 3Øx20Amp, 3Øx25Amp)
Ocean	171.75"x93" 436cm x 236cm	50.5" 128.5 cm	NA / Euro 5500/2x3600	1347 Gallons 5100 Litres	1909 Lbs 866 Kg	240 Volt, 50 Amp (Epic series require 60amp)	1Øx32Amp, 3Øx16Amp (Epic series require 1Øx40A, 3Øx-16Amp, 3Øx20Amp, 3Øx25Amp)
Okanagan	171.75"x93" 436cm x 236cm	50.5" 128.5 cm	NA / Euro 5500/2x3600	1347 Gallons 5100 Litres	1909 Lbs 866 Kg	240 Volt, 50 Amp	1 phase x 32Amp or 3 phase x 16Amp
Summit	93"x93" 235cm x 235cm	38.75" 98 cm	NA / Euro 5500/2x3600	371 Gallons 1405 Litres	935 Lbs 424 Kg	240 Volt, 50 Amp (Epic series require 60amp)	1Øx32Amp, 3Øx16Amp (Epic series require 1Øx40A, 3Øx-16Amp, 3Øx20Amp, 3Øx25Amp)
Summit XL	117"x93" 297cm x 235cm	38.75" 98 cm	NA / Euro 5500/2x3600	525 Gallons 1988 Litres	1056 Lbs 479 Kg	240 Volt, 50 Amp (Epic series require 60amp)	1Øx32Amp, 3Øx16Amp (Epic series require 1Øx40A, 3Øx-16Amp, 3Øx20Amp, 3Øx25Amp)
Tundra	93"x93" 235cm x 235cm	38.75" 98 cm	NA / Euro 5500/2x3600	449 Gallons 1700 Litres	950 Lbs 431 Kg	240 Volt, 50 Amp (Epic series require 60amp)	1Øx32Amp, 3Øx16Amp (Epic series require 1Øx40A, 3Øx-16Amp, 3Øx20Amp, 3Øx25Amp)
Wolverine	171.75"x93" 436cm x 236cm	50.5" 128.5 cm	NA / Euro 5500/2x3600	1347 Gallons 5100 Litres	1909 Lbs 866 Kg	240 Volt, 60 Amp	1Øx40Amp, 3Øx16Amp, 3Øx20Amp, 3Øx25Amp
Yukon	86"x86" 217cm x 217cm	41" 104 cm	NA / Euro 5500/2x3600	359 Gallons 1360 Litres	734 Lbs 333 Kg	240 Volt, 50 Amp	1 phase x 32Amp or 3 phase x 16Amp

* North American Spas can run single phase 240 Volt, 40, 50 and 60 amp, low level programming should be set to reflect what power is supplied. When supplied power is less than required the spa pack will adjust operation to not exceed available power. This may result in inability to operate all devices at once.

** European spas can run single and three phase with 16, 20, 25, 32 and 40amp. Low level programming should be set to reflect what power is supplied. When supplied power is less than required the spa pack will adjust accordingly to not exceed available power. This may result in inability to operate all devices at once. Refer to note on page 10.



Installation Instructions

Site Preparation

Please ensure the following:

- Always put your spa on a structurally sound, level surface. A filled spa can weigh a great deal. Make certain that the location you choose can support the weight of your filled spa.
- Locate your equipment compartment, which houses all of electrical components, in a place where you will have easy access for periodic spa care and maintenance.
- Allow adequate access to all other doors for service.

Outdoor Ground Level Installation

No matter where you install your new spa, it's important that you have a solid foundation for support. If you are installing a spa with a wooden pedestal floor outdoors, we recommend you place patio stones underneath spaced out evenly. The stones should be at least two inches thick and twelve inches square (30 cm x 30 cm). Even with stones in place, the spa will possibly settle and become uneven, and may require re-leveling over time. If you are installing a spa with a Forever Floor® outdoors, you may set it on virtually any surface, as long as it is firm and level.

Deck Installation

To be certain your deck can support your spa, you must know the deck's maximum load capacity. Consult a qualified building contractor or structural engineer. To find the weight of your spa, its contents and occupants, refer to the Spa Specification chart. This weight per square foot must not exceed the structure's rated capacity, or serious structural damage could result.

Your Arctic Spas® Dealer can help you with local information such as zoning regulations and building codes.

All Weather Pool Site Prep

Your new All Weather Pool should be placed on a prepared, uniformly solid and level surface (concrete pad, properly engineered wood deck, etc.). The AWP should not be placed directly on a lawn, bare ground, or gravel pad due to irregularities in the surface that may cause structural failure of the cabinet and shell that could void the warranty.



Balconies, concrete pads, and decks should be constructed to meet all builder codes and should be able to or exceed supporting 146 Lbs per square foot (7kPa).

Your Arctic Spa is equipped with access doors on all four sides. It is the customer's responsibility to provide access and ensure there is a minimum of 24" (600mm) all around the spa for service person access. Consult your sales person or service department on the different ways to achieve this clearance.



Electrical Specifications

WARNING!

All electrical hookups must be performed by a licensed electrician!

IMPORTANT CONNECTIONS:

(North American installation)

Neutral of the GFCI must be connected to the neutral bus.

Neutral from the spa must be connected to the breaker.

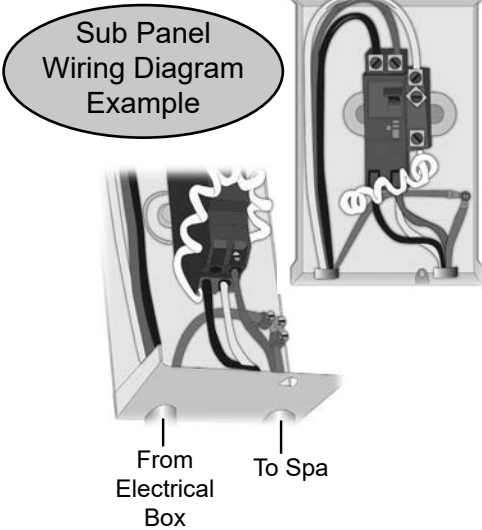

The Eco-Pak spa pack allows you to use all the features of our free app, onSpa®, for your smartphone. onSpa® has a wide range of user guides and information that will be useful with any spa pack. For detailed instructions on how to use onSpa, download the app here <http://www.arcticspas.com/documents/> or go to www.ArcticSpas.com

Electrical Installation Instructions

ARCTIC SPAS® MUST BE WIRED IN ACCORDANCE WITH ALL APPLICABLE LOCAL ELECTRICAL CODES. ALL ELECTRICAL WORK SHOULD BE DONE BY AN EXPERIENCED, LICENSED ELECTRICIAN AND APPROVED BY A LOCAL BUILDING/ELECTRICAL INSPECTION AUTHORITY.

The electrical supply must satisfy the requirements of the spa as marked on the certification label which is located adjacent to the spa controller (pack). If the ratings are not legible or cannot be found, please contact the factory for assistance. - DO NOT GUESS!

WARNING: Removing or bypassing any GFCI /RCD breaker will result in an unsafe spa and will void the spa's warranty.

IMPORTANT: Your Arctic Spa has been carefully engineered to provide maximum safety against electric shock. Remember, connecting the spa to an improperly wired circuit will negate many of its safety features.

Note to European customers:

8' Epic Series Electrical Requirements are 240 Volt, 40 AMP Single Phase or 2-20 AMP or 3-20 AMP or 3-16 AMP you have the choice of a 1, 2, or 3 phase power supply at 16, 20, 25, 32, 40, 50, & 60 amperages.

DANGER!

Shock Hazard.
DO NOT PROCEED if you are not a licensed electrician. This diagram is for reference only!

Startup Procedures

IMPORTANT:

Your Arctic Spa® has been thoroughly tested during the manufacturing process to ensure reliability and long-term customer satisfaction. Before filling the spa, wipe the spa shell clean with a soft rag. Make sure to fill spa through filter bucket.

The following instructions must be read and followed exactly to ensure a successful start-up or refill.

- 1) Ensure the electrical connections have been made in accordance with this manual.
- 2) Ensure all O-Rings have been installed into unions and unions have been tightened sufficiently.
- 3) Ensure all ball valves are open, and the drain has been closed. The spas drain fitting located on the external cabinet. Refer to page 16 for location information
- 4) Using a garden hose with a pre-filter, fill the spa with pre-filtered water to the bottom of the pillows (or approximately 6", 15 cm above the base of the floating weir).

Note: If your spa is equipped with Peak 2 Ozone ensure you fill the spa from the filter bucket that does not have the weighted filter weir.

- 5) Once the spa is filled to the proper level, turn the power to the spa on, by turning on the GFCI /RCD breaker in your panel.
- 6) The jet pump, heating system and all internal plumbing will achieve a partial prime as the spa is filled. To check the operation of the jet system and to remove any remaining air from the plumbing system, follow these steps:
 - a) **All Models:** Push the pump 1 button a second time to turn the pump to high speed. Allow to run for 1 minute.
 - b) **Signature, Epic, and Legend series:** Push pump 2 button also. This pump runs at high speed only. Run for one minute.
 - c) **Legend and Epic series:** Push pump 3 also. This pump runs at high speed only. Run for one minute. Once the jet system is fully operational (as indicated by strong, non-surging jets), priming of the spa is complete. Push each pump button once to turn the pumps off.
 - d) **Epic Series** push pump #4 and #5 buttons once to turn on and run for one minute.

IMPORTANT: Weak or surging jets are an indication of a low water level, a clogged filter cartridge, or an improperly adjusted filter weir.

- 7) Adjust the chemicals and balance the water according to your dealer's instructions. A guideline is also included in this manual, under the Water Maintenance Section.
- 8) Set the temperature control to the desired temperature (between 100°F and 104°F (38°C and 40°C), then place the insulated cover on the spa and allow the water temperature to stabilize (approximately 16 hours). Make sure you secure the cover in place using the cover locks.
Periodically check the spa water temperature.
When the water temperature climbs above 85°F (29°C), proceed to the next step.

- 9) Test and Adjust Sanitizer level (Chlorine ideal 1 - 3 ppm or Bromine ideal 3 - 5 ppm).
- 10) Rotate diverters to centre position and press "Pump 2" button on topside control panel for 5 seconds to activate the "Boost filtration system". When this system is enabled, "boo" is displayed on the screen. This will give 45 min of circulation and filtration to disperse the chemicals.
- 11) You can set the temperature (between 38°C and 40°C or 100°F to 104°F) by pressing the TEMP (^) and TEMP (v) buttons on the control panel. The spa will normally come up to temperature within 16 to 24 hours. Replace the spa cover while the temperature is reaching the set point.

IMPORTANT: For safety, you can lock your desired temperature setting.
Refer to the Topside Control Panel section for details.

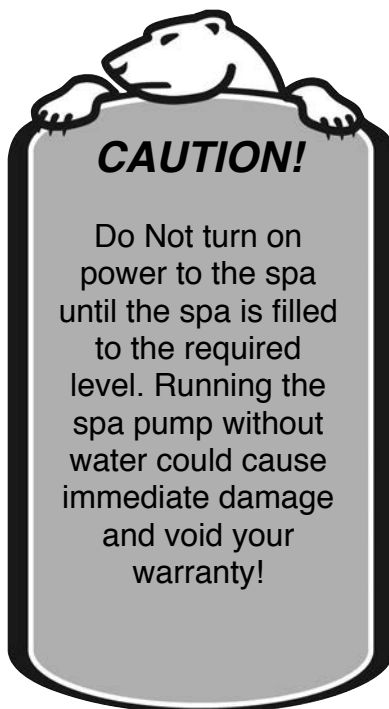

CAUTION!

If your spa or AWP is equipped with Spa Boy or ONZEN please consult the: Spa Boy Owners Manual or ONZEN User Guide for further setup requirements.

Spa Overview



A: Topside Control | See Topside Control Overview section in this manual.

B: Waterspouts | Control by an ON/OFF valve.

C: Neckjets | Rotating neck jets are designed for your own personal comfort and are controlled by an ON/OFF valve.

D: Monsoon Jet

E: Jets | All jets are adjustable and can be turned ON/OFF and can also be locked in the fully ON position, simply by rotating the Jet face.

F: Diverter | If your spa is equipped with a Diverter, its purpose is to distribute water pressure to varying jets or provide water pressure to the Monsoon Jet or both.

G: Venturi | Allows air into jets to boost jet performance when Pump 1 is on. Leave in the “closed” position when spa is not in use.

Jets



Single Pulse

Five Inch (5") Jets

The five-inch Hydro-massage jets give a wide circular massage. These jets are adjustable by turning the face of the jet clockwise for a stronger flow and counter-clockwise for a softer flow and eventually off. The Jet can also be locked in the fully ON (open) position by turning the face of the jet clockwise until it does not go any further. Then rotate again to allow the jet to override the lock stop.



Single Pulse



Neck Jet

Three Inch (3") Jets

The Turbo Single jets give a wide circular massage. The 3-inch jets are designed for a thorough massage of the muscles in your upper back, shoulders and neck. These jets are adjustable by turning the face of the jet clockwise for a stronger flow and counter-clockwise for a softer flow and eventually off. The Jet can also be locked in the fully ON (open) position by turning the face of the jet clockwise until it does not go any further. Then rotate again to allow the jet to override the lock stop.



Monsoon Jet (Certain models)

The Monsoon Jet is a large hydro-massage jet designed to maximize massaging action on a specific area of the body. It is located in the lower part of the spa to allow easy access for massaging feet, legs, hips and lower back. The intensity of the Monsoon Jet can be altered using one of the Fusion™ Diverter (the location varies depending on spa model). Consult your local dealer regarding which diverter lever or just jump in and experiment for yourself. On an 8ft Spa, the Epic series has a dedicated pump, pump 5 for the Monsoon Jet. There is no Diverter.

Therapy Air Jets (Optional)

When the Therapy Air System is turned on (see spa control functions), soft air bubbles are produced and enter the water all around you for an exhilarating massage.

Topside Control Panel

Your spa control has been specifically designed so that by simply connecting the spa to a properly grounded source, and following the start-up procedures in this manual, the spa will automatically heat to the set temperature. Many other functions, such as filtration, safety checks and maintenance reminders have been automated so that your spa experience will be as carefree as possible.

But you're in charge! The topside control (TSC) panel allows you to set the temperature, initiate the filtration cycle, control the lights, and activate or deactivate the pump(s) and blower. The TSC display responds to let you know you have pressed a button, and that the selected function has been performed.

Power-Up Detection

When spa is powered up it performs a check to confirm if the hi-limit probe is attached to the heater barrel. While this is happening "tSt" will be displayed. If the "tSt" fails, the code "HPT" will be displayed on the screen (Heater Probe Test). Please reference the quick reference guide on the next page for probable solutions.

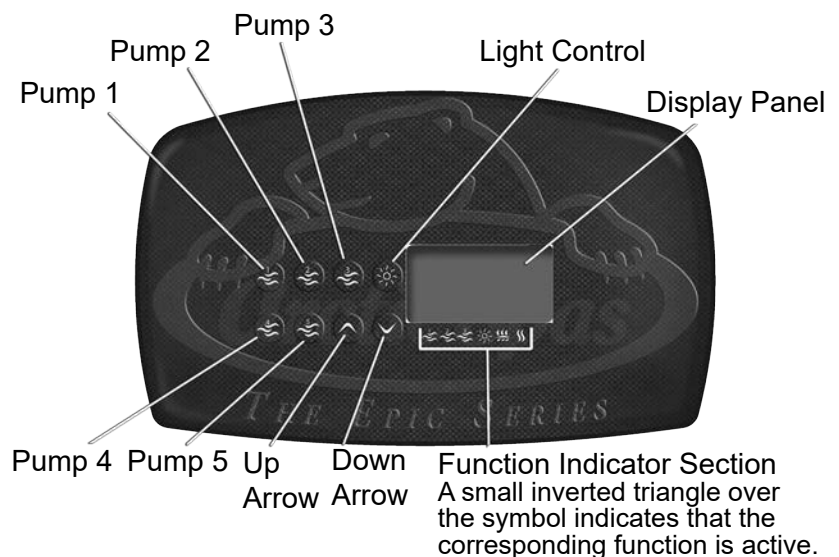
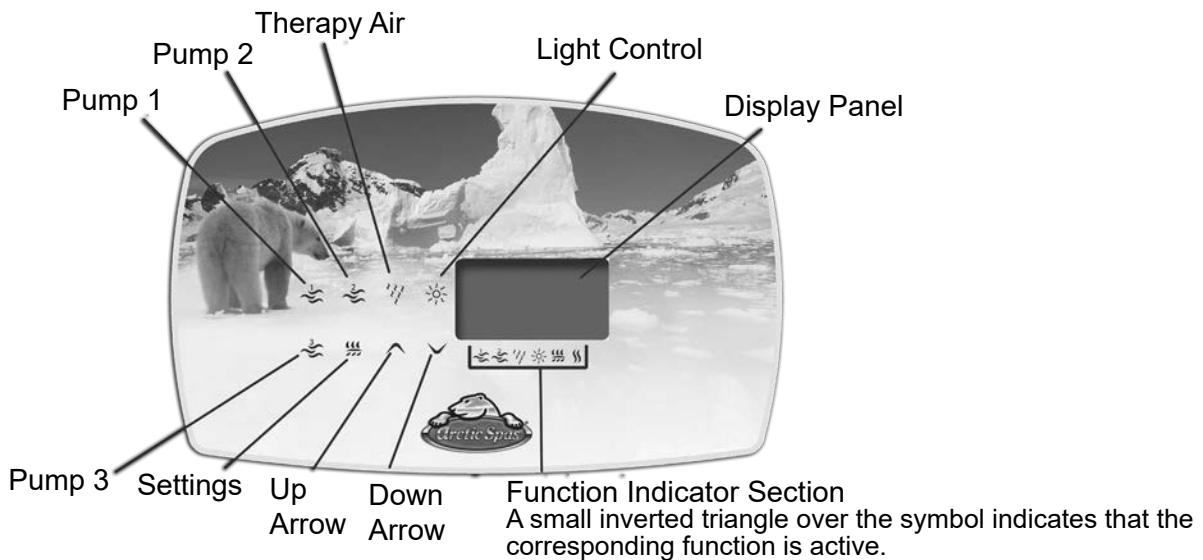

Quick Reference Guide

Firmware Revision 3.51.00.20

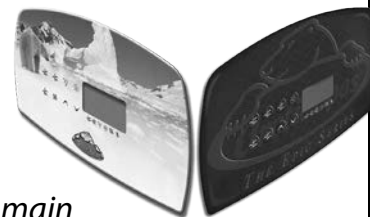

The Quick Reference Guide provides a quick overview of your spa's main functions and the operations accessible with your digital control pad.

- 1 Starting Pump 1:**
Press **Pump 1** button to turn Pump 1 on at low speed. Press a second time to turn Pump 1 to high speed. A third time turns Pump 1 off. A built-in timer automatically turns Pump 1 off after 20 minutes, unless it has been manually deactivated.
- ▼ The Pump 1 indicator lights up when Pump 1 is on at high speed. It flashes when Pump 1 is on at low speed.

- 2 Starting Pump 2:**
Press **Pump 2** button to turn pump 2 on. A second time turns Pump 2 off. A built-in timer automatically turns Pump 2 off after 20 minutes, unless it has been manually deactivated.
- ▼ The Pump 2 indicator lights up when Pump 2 is on at high speed.

- 3 Starting Pump 3:**
Press **Pump 3** button to turn Pump 3 on. Press a second time to turn Pump 3 off. A built-in timer automatically turns Pump 3 off after 20 minutes, unless it has been manually deactivated.

- 4 Starting Pump 4 (Epic series only):**
Press **Pump 4** button to turn Pump 4 on. Press a second time to turn Pump 4 off. A built-in timer automatically turns Pump 4 off after 20 minutes, unless it has been manually deactivated.

- 5 Starting Pump 5 (Epic series only):**
Press **Pump 5** button to turn Pump 5 on. Press a second time to turn Pump 5 off. A built-in timer automatically turns Pump 5 off after 20 minutes, unless it has been manually deactivated.

- Starting the blower:**
Press the **Blower** button once to turn on the Therapy Air (TA) blower. A second time turns the TA blower off.

- Setting water temperature:**
Use **Up** or **Down** arrow button to regulate water temperature. The temperature setting will be displayed for 5 seconds to confirm your new selection. Water temperature can be adjusted by 1° increments from 59 to 104°F (15 to 40°C).
- 🔑 The temperature symbol indicates the desired temperature, NOT the current water temperature.

- Automatic water heater start:**
When water temperature is 1°F (0.5°C) lower than the Set Point, the heater will automatically turn on & heat until the water temperature reaches 1°F (0.5°C) above the set point.
- ▼ The Heater indicator lights up when the heater is on.

- SpaBoy Boost (if equipped)**
Press and hold the Pump 2 key for 10 seconds to initiate SpaBoy boost which runs the SpaBoy electrode for 30 minutes regardless of the ORP setting. When activated "Sbb" will be displayed

- Invert Display**
Push and hold the blower key for 20 seconds to invert the display.

- Temperature unit:**
Press and hold the **light** button for 5 seconds to toggle between °F and °C.

- Turning the light on:**
If your Spa is equipped with an original lighting package you can toggle through the the color options by pressing the light button ON/OFF/ON. Press **Light** button to turn light on. Press a second time to turn light off. A built-in timer automatically turns it off after 2 hours, unless it has been manually deactivated. The Light indicator is displayed when the light is on.

- Waterfall**
The waterfall will be operated by turning pump 1 on and adjusting a small bear paw control nearest to the waterspouts to vary the amount of flow. This can vary in location by the model and series.

- Standby mode:**
Press and hold **Pump 3** button for 5 seconds to enter standby mode. The "stby" message is displayed and heating & filtering will be disabled for 30 minutes. Pressing any button will exit standby. Note: If the system is turned down while the heater is on, Pump 1 will run for an additional 3 minutes.

- Pad Lockout:**
There are two modes you can choose from: Full or partial lock. Full lock means that all keypad functions are locked. Partial lock means that only the basic functions will remain accessible (pumps, blower, light). Locking your digital control pad:
Press and hold **Pump 1** for 5 seconds. The display will show "LocP", with "P" representing partial lock. Release the button and the keypad will be in Partial lock mode. Keep button pressed down for 5 more seconds if you want to be in Full lock mode. The "LocF" message will then be displayed. When control pad is locked, all automatic functions will run as usual. If a button is pressed down, a "LocP" or "LocF" message will be displayed for 1 second. To unlock the keypad, simply press and hold Pump 1 button again for 5 seconds.

- Boost Mode:**
Press and hold Pump 2 button for 5 seconds to enable Boost mode. In this mode, Pump 1 high speed and the ozonator will run for 45 minutes. When enabled, "boo" message is displayed. This mode is used to speed up filtration after intensive use of the spa or to help mix chemicals just added to the spa. Pressing any button will exit boost mode.

- Fogger Waterfall**
The Fogger Waterfall is controlled by pressing and holding the "light" button for 2 seconds. This will activate the lights, fogger and the small pump that operates the system. Pressing the "light" button once will turn the Fogger/Waterfall off. The system will stay active for 2 hours unless it has been manually turned off using the "light" button.

- It is advisable on first start up or restart that water is put into the opening of the Fogger/Waterfall to fill up the area to prevent premature damage to the Fogger units.

PROGRAMMING THE SETTINGS

During a filter cycle:

- Pump 2, Pump 3 (Pump 4 & Pump 5 on an epic series spa) and the blower run for **one minute, then**
- Pump 1 runs at low speed for the programmed number of hours (see below), and
- The ozonator is turned on.

Press the Filter button (pump 5 on epics) to enter into your filtration options. Your display will show "Sett" and from here you will be able to choose your settings.

Press your Filter/Pump 5 button again to display your first option. This is your Ozone Cycle Duration (if equipped).

Use your arrow keys to select your Ozone Cycle Duration. You can select from 1 to 24 hours per day.

Press your Filter/Pump 5 button again. Your display will now show the settings for your Onzen system (if equipped).

Use your arrow keys to select your Onzen Cycle Duration. You can select from 1 to 24 hours per day.

Press your Filter/Pump 5 button again. Your display will now show the settings for your Filter Duration.

Use your arrow keys to select your Filter Duration in hours. You can select from 0 to 6 hours.

Press your Filter/Pump 5 button again. Your display will now show the settings for your Filter Cycle Frequency.

Use your arrow keys to select your Filter Cycle Frequency from 1 to 4 times per day.

Please note: You will see the options that are applicable to your spa. If you have neither ozone nor onzen, you will proceed directly into setting your Filter Duration. Also, though an Epic topside is of a different design, the steps are as shown. You can move backwards through the settings by pressing the Pump 3 button (Pump 4 on Epic series spas). The Pump 1 button will allow you to exit without saving any changes. When you get to the end of the options, press the filter key one last time to save changes and begin a filter cycle immediately. If you do not press the filter key again your changes will be saved and the filter cycle will begin when you have programmed it to do so.

45 Minute filter cycle time-out: If you turn a pump, blower or light on during a filter cycle, the cycle will be interrupted and will only resume 45 minutes after you (or the system) have turned the last active output off.

TROUBLESHOOTING

ERROR CODE DESCRIPTION

<i>PRR</i>	Temperature probe is disconnected from the base board
<i>HL (Flashing)</i>	Over temperature. The water temperature of the spa is > 112°F (44.5oC)
<i>HL (Solid)</i>	High limit. The temperature of the heater barrel is > 119°F (48oC)
<i>FLO</i>	Flow Switch Open. The flow switch is not detecting adequate flow while pump 1 is running.
<i>FLC</i>	Flow Switch Closed. The flow switch is detecting flow while pump 1 is off.
<i>OTH</i>	Heater barrel is heating too quickly. Only checked while the heater is on.
<i>FREEZE PROTECT</i>	Freeze protect mode. Starts when the water temperature is < 50°F (10°C) and ends when the water temperature reaches 59°F (15°C)
<i>dECL</i>	Requested feature would overload the breaker and as a result has been declined.
<i>GF</i>	Requested function has been disabled due to a suspected ground fault.
<i>LocP</i>	Topside has been partially locked
<i>LocF</i>	Topside has been fully locked
<i>+S+</i>	When spa is powered up it performs a check to see if the hi-limit probe is attached to the heater barrel. While this is happening "tSI" will be displayed.
<i>HPT</i>	If the heater probe test fails then HPT will be displayed.
<i>Hd</i>	If the hi-limit probe is disconnected from the board "Hd" will be displayed.
<i>PH</i>	If Spa-Boy is installed and the pH is above 8.2 "pH" will be displayed.

Note: For an expanded description of the Error Codes, download the Error Codes Quick Reference Card for the following link <http://www.arcticspas.com/documents/> or go to www.ArcticSpas.com

Further troubleshooting guidance is also available from the following Link: myarcticspa.com.
Open the Troubleshooting tab along the horizontal tool bar

* If activated in Low-level programming the lights will flash when there is an error code present

Spa Care and Maintenance

Your Arctic Spa® is manufactured from the highest quality, most durable materials available. Even so, the spa care and maintenance program you develop will ultimately determine how long your spa and its individual components will last. Regular maintenance following the advice in this section will help you to protect your investment.

IMPORTANT: Before performing any maintenance on your spa, make a visual inspection of the spa to get an understanding of what condition it may be in and if anything looks out of the ordinary. If any part appears to be damaged, loose or missing, do not proceed. Contact your Factory Authorized Dealer immediately.

Draining the Water

Detergent residues and dissolved solids from bathing suits and chemicals will gradually accumulate in your spa's water. Normally, in about three to four months the water will become difficult to balance and should be replaced. Showering without using soap prior to entering the spa or using only the rinse cycle when laundering your bathing suit will help to reduce detergent residue in the spa water. However, foam problems are more likely to be caused by a build up of organic pollutants in the spa, mostly from body oils. If you're using your spa frequently with a high bather load the water will need to be replaced more often. Spa water gradually loses quality because of build-ups of unfilterable pollutants.

IMPORTANT: If using traditional chemicals remember to change your water every three to four months. If using SpaBoy you can get 6 months to two years in between water changes.

To Drain Your Spa:

1. Shut off the GFCI /RCD breaker located in the sub panel or the quick disconnect.
2. Locate the hose adapter and thread on to your garden hose.
3. Remove the drain plug, and thread in the adapter.
4. When the adapter is threaded all the way in the drain will automatically open and begin draining.

Note: All Arctic Spas® models will drain through the floor drain. Equipment such as the pump(s) and heater will drain. All models will leave a small amount of water in the foot well. Any water remaining in the plumbing or equipment after draining will only need to be removed if the spa is being winterized.

4. When empty, inspect the spa shell and clean as required.
5. Close the drain valve.
6. Refill the spa BEFORE restoring power.

IMPORTANT: With reusable filters, it is necessary to rinse the filter cartridges weekly. Every month, and each time the spa is drained for cleaning, clean the cartridges in filter cleaner. (With Arctic Spas disposable filters, simply replace the cartridge whenever the spa is drained, or about every three months).



Filtration System

The use of Clarifiers and Foam inhibitors is not recommended with disposable filters!

Arctic Spas® are equipped with balanced filtration, meaning that the filter cartridges are sized to meet the needs of the pump system. As with any water filtering system, the filter cartridge may become clogged, resulting in reduced water flow. It is important to maintain a clean, unobstructed filter system. We recommend that your filter cartridge be replaced with an Arctic Pure® disposable filter cartridge every three (3) months.

Filter Cartridge Removal and Installation

1. Put the spa in Standby mode using the on/off button on the topside control panel.
2. Remove the telescoping filter cylinder
3. Unscrew the filter cartridge and either clean the reusable filter or discard the disposable filter.
4. Re-thread the clean or new filter.
5. Slide the telescoping filter cylinder back into the filter bucket.

Care of Spa Pillows

The spa pillows used in many of the Arctic Spas® models will provide years of comfort if treated with care. They have been positioned above the water level to minimize the bleaching effects of chlorinated water and other spa water chemicals. To extend their life, whenever the spa shell is being cleaned, the spa pillows should be removed and cleaned. Body oils can be removed with a mild soap and water solution. ALWAYS rinse off the spa pillows thoroughly to remove any soap residue. The pillows can be conditioned with Arctic Pure® Cover Renew cleaner after cleaning. If the spa is not going to be used for a long period of time (that is, during a vacation or if the spa is being winterized), or when the spa water is being super-chlorinated, the spa pillows should be removed until the next use of the spa.

To remove and replace the spa pillows:

1. Pull the pillow directly upwards until it is fully extended. Next to the acrylic of the shell, there is a button that you press to allow you to pull the pillow upwards and out completely.
2. To reinstall the spa pillow, push the button and carefully insert pillow.





Care of the Spa Shell

Your Arctic Spa® has a fiberglass reinforced, Aristech® cast acrylic shell. Stains and dirt generally will not adhere to your spa's surface. A soft cloth or sponge should easily remove most dirt. Most household chemicals are harmful to your spa's shell. Sodium bicarbonate (baking soda) or vinegar can also be used for minor surface cleaning. Always thoroughly rinse off any spa shell cleaning agent with fresh water.

Service Notes:

1. Iron and copper in the water can stain the spa shell if allowed to go unchecked. Your Arctic Spas® Dealer stocks Arctic Pure® Best Defence to use if your spa water has a high concentration of dissolved minerals.
2. The use of alcohol or any household cleaners other than those listed to clean the spa shell surface is NOT recommended. DO NOT use any cleaning products containing abrasives or solvents since they may damage the shell surface. Damage to the shell by the use of harsh chemicals is not covered under the warranty.

MANUAL SAFETY COVER

 WARNING	 AVERTISSEMENT
AVOID DROWNING RISK	ÉVITEZ DE NOYER LE RISQUE
<small>KEEP CHILDREN AWAY. CHILDREN OR OBJECTS CANNOT BE SEEN UNDER COVER. REMOVE COVER COMPLETELY BEFORE ENTRY - BATHERS ENTRAPMENT POSSIBLE. NON-SECURED OR IMPROPERLY SECURED COVERS ARE A HAZARD. FAILURE TO FOLLOW ALL INSTRUCTIONS MAY RESULT IN INJURY OR DROWNING.</small>	<small>ENFANTS DE SUBSISTANCE PARTIS, DES ENFANTS OU LES OBJETS NE PEUVENT PAS ÊTRE VUS SOUS LA COUVERTURE. ENLEVEZ LA COUVERTURE COMPLÈTEMENT AVANT L'BAIGNEUR - OCCLUSION D'ENTRÉE POSSIBLE. LES COUVERTURES NON-FIXÉES OU INCORRECTEMENT FIXÉES SONT UN RISQUE. LE MANQUE DE SUIVRE TOUTES LES INSTRUCTIONS PEUT AVOIR COMME CONSÉQUENCE LES DOMMAGES OU LA NOYADE.</small>

Care of the Spa Cover

WARNING: The cover is a manual safety cover that meets or exceeds all prevailing requirements of ASTM Standards for spa safety covers when installed and used correctly as of the date of manufacture. Non-secured or improperly secured covers are a hazard. Open the cover to its fully open position before use. Be sure to inspect the cover for premature wear or deterioration. Over time, with use, there is a chance of normal cover wear and deterioration. To properly maintain your cover see directions below.

Vinyl Cover

The vinyl spa cover is an attractive, durable foam insulation product. Monthly cleaning and conditioning is recommended to maintain its beauty.

To clean and condition the vinyl cover:

1. Remove the cover from the spa and gently lean it against a wall or fence.
2. With a garden hose, spray the cover to loosen and rinse away dirt or debris.
3. Using a large sponge and/or a soft bristle brush, and using a very mild soap solution or baking soda, scrub the vinyl top in a circular motion. Do not let the vinyl dry with a soap film on it before it can be rinsed clean.
4. Scrub the cover's perimeter and side flaps. Rinse clean with water.
5. Rinse off the underside of the cover with water only (use no soap), and wipe it clean with a dry rag.
6. To condition the cover after cleaning, apply a thin film of Arctic Pure[®] Cover Renew to the vinyl surface and buff.

Care of the Spa Cabinet

Cedar Cabinet: When properly cared for, the wood cabinet of your spa will maintain its beauty for many years. Your Arctic Spa cabinet has been specially treated with Olympic Maximum Wood Stain. Use this stain or a similar product on a regular basis to protect the wood of the cabinet and keep your spa looking great for years to come.

The easiest method of maintaining your cedar cabinet and to keep your cedar cabinet looking as good as the day your spa was first delivered, is to apply one coat of oil to your cedar cabinet twice a year. Just before summer and again at the end of summer are the best times. In between oiling your cedar cabinet you can also clean and rejuvenate your cedar cabinet with Arctic Pure Cover and Cabinet Renew.

No Maintenance Cabinet: Wash with soap and water. (no harsh chemicals)

LED Light Replacement

All Arctic Spas® come equipped with two 12 volt underwater lights for night use. Should you need to change any light, follow these simple steps:

1. Make sure the lighting is turned off, by checking the topside be sure the light icon is not showing.
2. Remove the screws securing the equipment access doors; remove the doors.
3. Locate the reflector, which is secured into the light housing. Carefully rotate the reflector counter-clockwise until it comes off the light housing.
4. Carefully disconnect any cables (note the location of the cable(s), as the LED assembly has two sockets) and remove the light assembly from its socket or slot.
5. Install the new LED assembly in its slot or socket, then reconnect the cables.
6. To reinstall the underwater light, rotate the lamp assembly clockwise onto the light housing until secure. If your family lighting or ultimate lights quit working call your closest authorized service provider.



Vacation Care Instructions

If you plan to be away from home for 7 - 14 days, follow these instructions to ensure that the water quality of your spa is maintained.

1. Adjust pH as needed.
2. Ensure you have sufficient sanitizer to last until you return.
3. Shock the spa with Arctic Pure® Boost or Refresh.
4. Lower the temperature.

Upon your return:

1. Shock the spa with Arctic Pure® Boost or Refresh.
2. Ensure you have sufficient sanitizer for regular use.
3. Return the temperature to its original setting. You can use your spa once the residual sanitizer level falls within the ideal range.

Winterizing Your Spa

If you plan to leave your spa unused for a long period of time in severely cold weather, you should drain the spa to avoid accidental freezing due to a power or equipment failure.

We recommend your local authorized dealer winterize your spa. Freezing can severely damage your spa. Improper winterizing of your spa can void your warranty.

Aquatremor®, Aquatemor® Deluxe or WetTunes® Stereo (Optional)

With the new Eco-Pak which has both Bluetooth® connectivity, all of your music can now stream from a Bluetooth-enabled device. Simply open your bluetooth settings on your smartphone, search for "WAU-xxxxx", and connect. There is no password.

How to perform a software upgrade on your spa's Eco pack

There are three ways to update your spas software:

1. Download through the Arctic Spas App.
2. Download through the myarcticspa.com webpage, or
3. The following:
 1. You can find the latest software program at: arcticspas.com/support/downloads/

This will be a Zip file, you must unzip or decompress the file.

2. Put the program on a USB stick
3. Make sure there is no other content in the USB stick
4. Plug the USB stick into the processor card
5. Reset the power
6. Green and yellow lights will start flashing, wait until the yellow light goes out and just solid green is there (takes 40 seconds or so) do not remove the usb stick during the upload process.
7. Unplug the USB stick then recycle the power
8. Green and Yellow lights flash again and spa boots up with the new software.

Troubleshooting Spa Problems

1. **Nothing functions:** The GFCI Breaker has tripped or there is a power failure. Test GFCI Breaker. Turn breaker back on and see if spa powers up, if not contact your factory authorized dealer.
2. **Spa does not heat:** Check to see if the heat indicator is on or there are any error messages on the topside control panel. If the heat indicator is on and no error message appears contact your factory authorized dealer.
3. **Poor Jet Pressure:** First check to see that the jet(s) are turned on fully. Check your filter to see if it's clogged or dirty. Next, check to see if the jet(s) are obstructed or if the venturi air dial is turned on. Finally, check to see if the jet(s) are surging. If so, your pump is cavitating (sucking in air). This usually occurs when the water level is too low and can be solved by adding water to the spa. If the problem still persists, contact your factory authorized dealer.
4. **Light is not functioning:** Follow the LED replacement section.
5. **Spa comes on by itself:** This function is normal when heating and filtering. No action required.
6. **Spa doesn't drain completely:** The spa is drained by gravity. It will not always drain fully. It is not necessary to drain the spa in its entirety except when winterizing the spa. If you wish to remove the last little bit of water, we recommend you vacuum it out with a wet/dry vacuum.

Technical Support:

Instructional videos are available to assist you at <http://www.arcticspas.com/support/>

Important

This manual and its contents are subject to change without notice. Although Blue Falls Manufacturing has prepared this manual as accurately and precisely as possible, Blue Falls Manufacturing will not be liable for loss, injury or damages caused by improper servicing or by use of spa (improper or otherwise).

Arctic Spas® are Canadian built with the finest materials and advanced technology to withstand the harshest weather conditions. Performance and Reliability is the Arctic Spas® Customer Guarantee. If your spa cannot be repaired under our extensive warranty, Arctic Spas® will provide a replacement spa equal in value to the original purchase price of the defective spa. Our philosophy Guarantees you Customer Satisfaction. These are words we will stand behind in writing.

Water Maintenance

It's important to have clean water. Water maintenance is one of the least understood, but very important areas of spa ownership. Your dealer can guide you through the process of achieving and maintaining perfect water in your spa, given your local conditions. Your program will depend on your water's mineral content, how often you use your spa, and how many people use it. Here is our suggested step-by-step program:

General Information

There are three fundamental areas of water maintenance. They are (1) Water Filtration, (2) Water Sanitation, and (3) Chemical Balance/pH Control.

Although your spa's filter system is working several hours a day to remove particles from your water, it does not remove bacteria or viruses. Water sanitation is the responsibility of the spa owner. It can be achieved through the regular and periodic (daily, if necessary) addition of an approved sanitizer. The sanitizer will chemically control the bacteria and viruses present in the spa water. Bacteria and viruses can grow quickly in under sanitized spa water. The water's chemical balance and pH control are also the responsibility of the spa owner. You will have to add chemicals to maintain proper levels of Total Alkalinity (TA), Calcium Hardness (CH) and pH. Proper water balance and pH control will minimize scale buildup and corrosion of metals, extend the life of the spa, and allow the sanitizer to work at maximum efficiency.

For Onzen System: Please refer to your Onzen User Guide for direction in water maintenance. (Pg.81)

For Spa Boy System: Please refer to your Spa Boy Owners manual for directions in water maintenance. (Pg.54)

Methods For Testing The Spa Water

Accurate water testing and analysis are an important part of effectively maintaining your spa water. To follow the Arctic Spas® recommended program, you must have the ability to test for:

- Total Alkalinity (TA)
- Calcium Hardness (CH)
- pH
- Sanitizer

Although reagent liquid test kits provide the highest level of accuracy, Test Strips are the most convenient testing method used by many spa owners. Keep in mind that test strips are susceptible to heat and moisture contamination, which will result in inaccurate readings. Very high sanitizer levels will also render test strips unreliable.

IMPORTANT: Always read and carefully follow the directions included with the Test Kit or Test Strips to ensure the accuracy of the test results.

Hints For Successful Water Testing

When using the reagent test kit:

- Always take water samples 30-45 cm (12" - 18") below the water surface.

- Rinse the test cells before and after each use.
- Do not dispose of test samples into the spa water.
- When adding drops of chemicals from the kit (the reagents) into the test block, hold the bottle vertically and add the drops slowly to be sure the correct quantity is used.
- The reagents should be replaced on a yearly basis to maintain the accuracy of the test results.

Basic Chemical Safety

When using chemicals, read the labels carefully and follow directions precisely. Though chemicals protect you and your spa when used correctly, they can be hazardous in concentrated form. Always observe the following guidelines:

- ALWAYS KEEP CHEMICALS OUT OF CHILDREN'S REACH.
- NEVER MIX CONCENTRATED CHEMICALS TOGETHER.
- ALWAYS THOROUGHLY RINSE ANY CONTAINER USED TO MIX CHEMICALS AFTER USE.
- ALWAYS RINSE OUT ANY EMPTY CHEMICAL STORAGE CONTAINER BEFORE DISPOSAL.
- Accurately measure the quantities specified. Do not overdose your spa. Amount required will vary depending on water condition, quantities to be used are only guidelines.
- Store chemicals in a cool, dry, well ventilated place.
- Always keep chemical containers closed when not in use.
- Don't inhale fumes or allow chemicals to come in contact with your eyes, nose, or mouth. Wash your hands immediately after use.
- Follow the emergency advice on the product label in case of accidental contact.
- Never smoke around chemicals. Some fumes can be flammable.
- Don't store any chemicals in the spa equipment compartment.

Adding Chemicals to the Spa

Most chemicals (does not include any slow dissolving chemicals) can be added directly to the spa while the pump(s) is running on high speed, for a minimum of 10 minutes.

IMPORTANT WHEN USING ARCTIC PURE® BOOST OR REFRESH TREATMENT

NOTE: After administering a super chlorination treatment or non-chlorine shock to your spa, leave the cover open for a minimum of 20 minutes to allow the oxidizer gas to vent. A high concentration of trapped oxidizer gas which may exist as a result of the shock treatment (not daily sanitation) may eventually cause discoloration or vinyl degradation to the bottom of the cover. This type of damage is considered chemical abuse and is not covered under warranty.

The Arctic Pure® Water Maintenance Program

Following the Arctic Pure® water maintenance program will save you time and frustration and ensure clear, clean spa water.

Remove Excess Minerals

Most tap water has minerals such as Calcium, Copper, Iron, Manganese and Sodium in it, and the

circulation of water can cause the erosion of metals from spa equipment which can present possible scaling and staining problems in your spa. Cases of source water with high minerals (such as some well water):

- 1. We recommend you add 3 1/2 tablespoons (48 grams) of Arctic Pure[®] Best Defense per 1000 litres (265 gallons) of water while filling your spa.

Balance the Total Alkalinity (TA)

1. The recommended Total Alkalinity (TA) for your spa water is 80-120 ppm.
2. Total Alkalinity is a measure of the total levels of carbonates, bicarbonates, hydroxides, and other alkaline substances in the water. TA is referred to as the water's "pH buffer". In other words, it's a measure of the ability of the water to resist changes in pH level.
3. If the TA is too low, the pH level will fluctuate widely from high to low. Fluctuations in pH can cause corrosion or scaling of the spa components. Low TA can be corrected by adding Arctic PureTM Perfect Balance.
4. If the Total Alkalinity is too high, the pH level will tend to be high and may be difficult to bring down. The pH can be lowered by using Arctic Pure[®] Adjust Down.
5. Once the TA is balanced, it normally remains stable, although some sanitizers, and the addition of more water with a high or low alkalinity will raise or lower the TA reading of the water.
6. When the Total Alkalinity is within the recommended range, proceed to the next step.

Balancing the pH

1. We recommended a pH range for your spa water of; 7.2-7.6
2. The pH level is the measure of acidity and alkalinity. Values above 7 are alkaline; those below 7 are acidic. Maintaining the proper pH level is extremely important for:
 - Optimizing the effectiveness of the sanitizer.
 - Maintaining water that is comfortable for the user.
 - Preventing equipment deterioration.
 - Preventing cloudy or odorous water.
3. If the spa water's pH level is too low, the following may result:
 - The sanitizer will dissipate rapidly.
 - The water may become irritating to spa users.
 - The spa's equipment may corrode.If the pH is too low, it can be increased by adding Arctic Pure[®] Adjust Up to the spa water.
4. If the pH level is too high, the following may result:
 - The sanitizer is less effective.
 - Scale will form on the spa shell surface and the equipment.
 - The water may become cloudy.

If the pH is too high, it can be decreased by adding Arctic Pure[®] Adjust Down to the spa water.

5. It is important to check the pH on a regular basis. The pH will be affected by the bather load, the addition of new water, the addition of various chemicals, and the type of sanitizer used.
6. When the pH is within the recommended range, proceed to the final step.

Calcium Hardness (CH)

Most spa manufacturers recommend a Calcium Hardness (CH) level for your spa of 150-200 ppm. However, we do not recommend adding calcium to your spa if your spa water is above 100 ppm, or if your incoming water has a very low level of calcium hardness.

Warning: When calcium falls out of suspension it can collect on the heater and pump, and shorten their life.

Sanitize the Spa

Sanitizer is extremely important for killing algae, bacteria and viruses, and preventing unwanted organisms from growing in the spa. At the same time, you don't want too high a sanitizer level, or it can irritate your skin, lungs and eyes.

1. Always maintain the sanitizer level in your spa at the recommended level for each type of sanitizer.

2. We recommend the following sanitizers:

Chlorine System:

- Arctic Pure[®] Chlorine Tablets
- Arctic Pure[®] Refresh
- Arctic Pure[®] Boost

Bromine System:

- Arctic Pure[®] Brominating Tablets
- Arctic Pure[®] Refresh
- Arctic Pure[®] Peak Boost

Important: Sanitizers are acidic and will decrease the Total Alkalinity. Regular testing and balancing of TA is extremely important with these products.

Important: Always remove the floating dispenser while the spa is in use.

Remove dispensers with a plastic bucket (keeping submerged) and store out of reach of children until spa use has ended.

Using Chlorine System

CAUTION: The use of personal protective equipment (rubber/latex/vinyl gloves, eye protection) is recommended while handling the dispenser or the pucks.

Start-up:

1. Add pucks to floating dispenser and open to setting 4.
2. Add 7 tablespoons (100 grams) of Arctic Pure[®] Refresh per 1500 litres (396 gallons) of water.
3. Add 1 tablespoon (14 grams) of Arctic Pure[®] Spa Boost per 1000 litres (265 gallons) of water.
4. Test the Chlorine level. Once the chlorine reads within the ideal range (1-3 ppm) turn tablet dispenser down to 1 - 2 (more or less according to bather load).

Weekly:

1. Add pucks to floating dispenser and reset the setting if necessary.
2. Add 7 tablespoons (100 grams) of Arctic Pure[®] Refresh per 1500 litres (396 gallons) of water.

Important: Arctic Pure[®] Refresh significantly reduces pH and TA. One hour after adding Arctic Pure[®] Refresh test and adjust TA and pH as needed.

Bromine System:

Note: If you are planning to use your new spa right away, Peak Boost must be added first. Follow directions for adding Peak Boost from this page.

1. Fill floating dispenser with pucks and open to setting 7.
2. Add 7 tablespoons (100 grams) of Arctic Pure[®] Refresh per 1500 litres (396 gallons) of water.
3. Add 2 1/2 tablespoons (35 grams) of Arctic Pure[®] Peak Boost per 1000 litres (265 gallons) of water, to establish a Bromide reserve.
4. Test the Bromine level. Once bromine reads within the ideal range (3-5 ppm) turn tablet dispenser down to 2 or 3 (more or less according to bather load).

Weekly

1. Twice a week test and adjust Total Alkalinity, pH and Bromine levels.

Important: Arctic Pure[®] Refresh significantly reduces pH and TA. One hour after adding Arctic Pure[®] Refresh test and adjust TA and pH as needed.

The use of Clarifiers and Foam inhibitors is not recommended with Silver Sentinel Disposable filters!

IMPORTANT: Chemical doses given in this manual are for reference ONLY. ALWAYS refer to product label for instructions.

Common Spa Water Problems~Cause & Remedy

PROBLEM	POSSIBLE CAUSES
CLOUDY WATER	<ul style="list-style-type: none"> A. Poor Filtration B. Suspended particles C. Organic contaminants build up D. pH high E. Total alkalinity high F. Combined chlorine in the water G. High dissolved solids H. Hardness too high
COLOURED WATER	<ul style="list-style-type: none"> A. Dissolved metals from water source B. Low chlorine/bromine levels C. Fragrance
FOAMING	<ul style="list-style-type: none"> A. High concentration of oils and organics being agitated by the jets and/or Therapy Air
SCALE DEPOSITS	<ul style="list-style-type: none"> A. High Calcium level, high pH, high alkalinity
ODOR	<ul style="list-style-type: none"> A. High level of organic contaminants, combined with chlorine
EYE/SKIN IRRITATION	<ul style="list-style-type: none"> A. pH too low B. Combined chlorine due to high concentration of organic contaminants C. Allergic reaction to sanitizer D. Bacterial contamination
NO CHLORINE/ BROMINE READING	<ul style="list-style-type: none"> A. High concentration of contaminants using up sanitizers B. Test kit reagents ineffective

SOLUTIONS

- A. Dirty filter, clean with Arctic Pure® Filter Restore (not with disposable filter). Increase Filter cycle or increase filtration times via the topside control or App.
- B. Add Arctic Pure® Easy Clear
- C. Shock treatment with Arctic Pure® Refresh
- D. Add Arctic Pure® Adjust Down until level reads 7.2-7.6
- E. Add Arctic Pure® Adjust Down to adjust TA level to 80-120 ppm
- F. Shock treatment until combined chlorine is eliminated (see container instructions)
- G. Empty spa and refill
- H. Add Arctic Pure® Best Defence until level reads 100-280 ppm

- A. Use Arctic Pure® Best Defence and have your dealer check your water balance
- B. Add Arctic Pure® Boost treatment to raise chlorine levels and test chlorine levels or for Bromine system add Peak Boost & test Bromine levels
- C. Stop the use of fragrance

- A. Shock treatment with Arctic Pure® Refresh.

- A. Drain partially, add Arctic Pure® Best Defence, correct pH level to 7.2 - 7.6 and alkalinity to 100-130 ppm.

- A. Check pH and adjust as required.
- B. Shock with Arctic Pure® Refresh, add Boost or Peak Boost dependent on whether you have a chlorine or bromine system
- C. Dilution of water will reduce contaminants and odor.
- D. Check any ozone system is operational

- A. Add Arctic Pure® Adjust Up until level reads 7.2 - 7.6 ppm
- B. Add Arctic Pure® Refresh, add Boost or Peak Boost.
- C. Change from Bromine to Chlorine or vice versa.
- D. Drain and refill spa.

- A. Add sanitizers until levels are up to the recommended levels
- B. Replace test kits at least once a year
- C. Chlorine/Bromine level very high and is bleaching test reagent, Allow sanitizer levels to recede by opening cover and running jets.



Warranty

Spa Shell~Lifetime

Arctic Spas® warrants the spa shell to the customer against water loss due to structural failure for as long as the original customer shall own the spa.

Equipment & Plumbing~5 years

Arctic Spas® warrants the spa's electrical equipment components ~ specifically the pump(s) *(please refer to detailed pump warranty on the reverse under "Detailed Pump Warranty"). Factory installed Peak I and Peak II, Therapy air system, Skyfall fogger components, RossExhaust™, Ultimate Lighting controls and LED's, Heater and control system against malfunctions due to defects in materials and workmanship for a period of five years to the original customer from the date of delivery. This warranty includes all parts and on site labour necessary to repair the spa.

Other Components~5 years

Arctic Spas® warrants the fuses, lights (blue LED, northern lights), WIFI, jet inserts**, topside control overlays, weir assemblies, diverter handles and caps, air control handles and caps, plastic cover clips, chrome trim to be free of defects in workmanship and materials for a period of five years to the original customer from the original date of delivery. Includes only parts necessary to repair, not labour. **jet inserts (including Titanium) are not warranted against discolouration, rusting or fading.

Shell Surface~5 years

Arctic Spas® warrants the shell surface to the customer against water loss due to material failure including cracks, blisters, peeling and delaminating for a period of five years to the original customer from the original date of delivery. Includes parts and on site labour necessary to repair.

Cover~3 years

Arctic Spas® warrants the Castcore® cover against malfunctions due to defects in materials and workmanship for three years to the original customer from the original date of delivery. Includes parts necessary to repair. (Normal wear and tear is not included in this warranty, when used with a cover lifter seam damage will be considered normal wear and tear)

Onzen™ System ~ 2 years

Factory-installed Onzen systems will have a 2 year warranty on labor and components, with the exception of the electrode. The electrode has a 30 day parts warranty against defects in materials and workmanship. The electrode is a consumable part that needs to be changed periodically by the spa owner. Onzen systems that are retro-fitted (installed after manufacture of the spa) by authorized Arctic Spa technicians will have two year parts warranty and it will not include a labor component. Not to exceed the spa warranty whichever comes first. Note, in order to process a warranty claim the Arctic Spa factory warranty department may need to contact the spa owner directly via email or phone. It is the responsibility of the Arctic Spa dealer to provide this contact information to the warranty department. This warranty may be void if the spa is operated with water salt concentrations outside the recommended level of 2000 to 2500 parts per million (ppm). Damage to other spa components unrelated to the Onzen system as a result of leaking pump seals are specifically not covered by this warranty. For example, heaters, heater barrels, jets, grab rails, pump seals, and pump motors are not covered in this case. Spa water quality and any damage caused by water chemistry imbalance are not covered by this warranty. Warranty work must be completed by an authorized Arctic Spa dealer. The Onzen system is not a fully automatic water treatment system. It is designed to minimize water maintenance under typical user loads and may therefore require supplemental chlorination and water chemistry balancing. (Arctic Pure brand spa chlorine is called Boost). The spa owner is responsible for ensuring safe water chemistry and conditions. The Onzen system must be used with Arctic Pure brand salt blend, which has been developed to protect the spa components. The use of alternative brands of salt may damage the spa components, can be detected by spa technicians, and will void this warranty.

Spa Boy~ 5 years

Arctic Spas warrants the Spa Boy system against malfunctions due to defects in materials and workmanship for 5 years from the original date of delivery to the original customer on factory installed systems, except the user replaceable Spa Boy Electrode which has a 30 day warranty, needs to be replaced annually. This warranty includes parts and on site labour necessary for the repair. Spa water quality and other damages resulting from water imbalance are specifically not covered by this warranty. Warranty work must be completed by authorized Arctic Spas retailers only. Spa Boy retro fitted kits (installed after manufacturer of the spa) will have a 5 part only warranty. Not to exceed the spa warranty, whichever comes first.

No labour warranty is provided by Arctic Spas for retrofitted Spa Boy systems. Disclaimer: This is not an automatic water care system. The system is set up for typical spa use. The spa user is ultimately responsible for maintaining proper sanitary water conditions. Use of salt other than

Arctic Pure Sea Salt. Blend will damage the Spa Boy components and void the warranty. The Arctic Pure Sea Salt blend has been developed to protect Spa Boy components from damage and the use of alternative salt blends will be easily detected by technicians.

This warranty may be void if the spa is operated with water salt concentrations outside the recommended level of 2000 to 2500 parts per million (ppm).

Damage to other spa components unrelated to the Spa Boy system as a result of leaking pump seals are specifically not covered by this warranty. For example, heaters, heater barrels, jets, grab rails, pump seals, and pump motors are not covered in this case.

Aquatremor® ~ 3 years

Arctic Spas® warrants the factory installed Aquatremor® Bluetooth sound system against malfunctions due to defects in materials and workmanship for three years to the original customer from the original date of delivery. Includes parts and on site labour necessary to repair. iPod® and waterproof case are manufacturer direct warranties. Aquatremor® Deluxe pop up speakers are warranted against defects in materials and workmanship for one year. Aquatremor retro fitted kits (installed after manufacturer of the spa) will have a 3 part only warranty. Not to exceed the spa warranty, whichever comes first.

WetTunes™ ~ 1 year

Arctic Spas® warrants the factory installed WetTunes™ Bluetooth sound system against malfunctions due to defects in materials and workmanship for one year to the original customer from the original date of delivery. Includes parts and on site labour necessary to repair. iPod® and waterproof case are manufacturer direct warranties. WetTunes retro fitted kits (installed after manufacturer of the spa) will have a 3 part only warranty. Not to exceed the spa warranty, whichever comes first.

Forever Floor®~5 years

Arctic Spas® warrants the Forever Floor® against rotting and structural cracking for a period of five years to the original customer from the original date of delivery. Includes parts and on site labour necessary to repair. This warranty only applies if there is a solid level pad.

DETAILED PUMP WARRANTY

Pump(s) are warranted against material and component failure. The pump shaft seal is covered under warranty. Damage resulting from a neglected leaking shaft seal is not covered under warranty. This includes but is not limited to bearing seizure, end bell failure, start switch failure, impeller failure and capacitor failure. It is the responsibility of the customer to report shaft seal failure before further damage can occur. Any pump component failure determined to be the result of defective material will be replaced under warranty. Arctic Spas® reserves the right to replace pump components, rather than the complete pump assembly. Vibration noise associated with normal pump operation is excluded from this warranty.

PERFORMANCE

To obtain service in the event of a defect or malfunction covered by this Limited Warranty, notify your Arctic Spa dealer as soon as possible and use all reasonable means to protect the spa from further damage. Upon proof of purchase, Arctic Spas®' agent or its designated service representative will correct the defect subject to the terms and conditions continued in this Limited Warranty. Pre-Approved claims must be executed within 60 days of Pre-approval, All existing claims expire upon expiration of warranty. *Please note that union connection leaks are considered to be user serviceable and are expressly excluded from the Limited Warranty. Damage resulting from union connection leaks are expressly excluded from the Limited Warranty. There will be no charge for parts and on site labour to the customer for a period of five years from the date of original delivery or six years from manufacturer's ship date, whichever comes first. Specifically equipment, plumbing and shell surfaces against malfunctions due to any defect in the material and workmanship within the Limited Warranty. Travel costs are the responsibility of the customer. Your limited warranty will cover a maximum of \$60 towards on site labor per each approved warranty claim. Service and/or travel costs are covered within the first 30 days of ownership to a maximum distance of 100KM from dealership or designated service outlet. If Arctic Spas® determines that repair of the covered defect is not feasible we reserve the right to instead provide a replacement spa equal in value to the original purchase price of the defective spa. Spa replacement is done only at the discretion of Arctic Spas®. Reasonable costs for the removal of the defective spa, and delivery and installation will be the responsibility of the spa customer. Freight will be paid to the nearest Arctic Spas® distribution centre while in the warranty period.

CONDITIONS OF WARRANTIES

All warranties provided hereunder extend only to the original customer of the spa if purchased by an authorized Arctic spas dealer and originally installed within the boundaries of the country where it was originally purchased. All warranties hereunder terminate upon transfer of ownership of a spa from the original customer or product leaving the country that it was purchased in. This warranty only applies within the service area where the spa was originally installed. Your limited warranty does not include repair travel mileage or for shipping cost assessed by your Factory Authorized Dealer or service agents. All events covered by this Limited Warranty hereunder must be repaired by a Factory Authorized Dealer of Arctic Spas®. The warranties will not include any costs of repair incurred by a non-factory authorized agent. To obtain service, the customer must contact the Factory Authorized Dealer in his area. In the event that a spa or component thereof must be returned to Arctic Spas® distribution centre, all freight costs are the responsibility of the spa customer. In all cases Arctic Spas® has sole responsibility for determining the cause and nature of failure of the spa and Arctic Spas® determination with regard thereto shall be final.

EXCLUSIONS

All warranties hereunder are void if the spa has been subject to alterations (including after-market accessories), misuse or abuse or any repair of the spa has been attempted by anyone other than a Factory Authorized Dealer of Arctic Spas®. Alterations include but not limited to, any change to the components, replacement of components or addition of components without the written authorization from Arctic Spas®. Misuse includes careless handling of the spa, damages caused by improper and/or non-certified electrical hook-ups, failure to operate the spa in accordance with the instructions contained in the owner's manual provided with the spa, including incorrect start-up procedures or dry firing of the spa, any use of the spa or any of its components in an application for which it was not designed, and damage caused by improper chemical balance (including any damage to spa components caused by scale build up to due to poor water chemistry), ice in the spa, overheating the spa or spa water, damage to the spa surface by allowing undissolved sanitizing chemicals to lie on the surface or if our spa has been used for commercial purposes. Spa covers are not warranted against chemical burn or discoloration. Spa covers are not warranted against water absorption or any damage resulting from water absorption. Any damage resulting from the mishandling of the spa cover in any way is not covered under warranty. Any damage caused by moving of the spa or improper installation (including insufficiently prepared or uneven ground) is considered abuse and any damage to the material or workmanship of the spa cabinetry and floor in shipping or handling are expressly excluded from the Limited Warranty. All Weather Pool must be placed on concrete pad or properly engineered deck.

Arctic Spas will not be responsible for power company issues or improper electrical installations, Damage and/or lack of performance resulting from high or low voltages outside operating parameters. Arctic Spas will not be responsible for software and product upgrades throughout the life of the spa.

Arctic Spas® expressly excludes warranty coverage on any of the following: Acts of nature including but not limited to damage resulting from lightning, storm, flooding, freezing, fire and any other acts of nature. Any spa installed in a commercial application. Any failure caused by improper cover use or or damage to the spa surface by leaving the spa outdoors without the hot tub cover in place. The heat created by leaving the spa in direct UV light without a cover may cause surface issues with the acrylic and may also cause plastic parts to warp, some fittings will leak or cease working as a result. These occurrences are not covered under warranty. The hot tub cover must be kept on the hot tub when not being used.

Scratches or micro-crazing in the spa shell reported after the day of installation are not covered under warranty. Micro-crazing is defined as an area of tiny shiny lines visible in areas on the surface of some thermoplastic sheets. This phenomena, although rare, is known to occur in many types of plastic sheet materials. The surfaces of thermoformed acrylic hot tubs are not immune to this possibility.

Damaged caused by unapproved sanitizers such as tri-chlor, acids, calcium hypochlorite, sodium hypochlorite, peroxides, any sanitizing chemical that may remain undissolved on the spa surface. **Any and all sanitation systems or chemicals used in your spa must be factory approved by Arctic Spas or your warranty is void.** You can check for a list of approved

systems and chemicals at arcticspas.com. Installation of not factory approved salt systems will void the warranty related to pump seals, metal part, jets, etc. Damage caused by any item(s) attached to or installed onto the spa, including but not limited to gazebos, cover lifters and cedar accessories. Any options or additional components that are not factory installed are not covered under warranty. Any damage or failure due to improper preparation for winter storage is not covered under warranty. Damage to pillows reported beyond the day of delivery will not be covered under warranty. Pillows are to be removed from the spa when not in use. Onzen and Spa Boy are the only factory approved salt system. Any damage resulting from the use of cover removing mechanisms is not covered under warranty. The Onzen and Spa Boy cell are considered a user serviceable component, replacement will be the responsibility of the customer.

DISCLAIMERS

Arctic Spas® will not be liable for loss of use of the spa or other incidental or consequential costs, expenses or damages that may include but not limited to, the removal of a permanent sun deck, sunroom, gazebo, or other custom fixture, any crane costs associated with the removal of the spa for service or replacement. Arctic Spas® shall not be liable for costs arising from water, filter cartridges and chemical loss. Under no circumstances shall Arctic Spas® or any of its representatives be liable for any injury to any person or damage to any property, howsoever arising from the spa. Arctic Spas® warranties are limited to a maximum amount of moneys received by Arctic Spas® with respect to the sale of the spa.

ALL WARRANTIES

The warranties contained herein are all of the warranties provided by Arctic Spas® to the customer, and to the extent permitted by law. Warranty registration (within 30 days of delivery) is the responsibility of the customer and is a condition of warranty coverage. This Warranty is offered as an extra benefit and does not affect your statutory rights. All warranties herein require that any claim must be submitted to Arctic Spas® within ten days of the time the defect is discovered, and must be accompanied by the original customer's receipt confirming purchase of the spa, which shows the date of purchase. All warranty claims must be submitted within the warranty period. Failure to provide such notice and information invalidates all warranties provided hereunder. Arctic Spas® reserves the right to repair or replace components or materials at its option. In certain cases, photographs may be required for proper evaluation before warranty coverage is determined. In the event a customer is unable to either obtain parts or satisfactory service from a Factory Authorized Dealer of Arctic Spas®, notice should be given immediately to the service department of the agent where the spa was purchased and to Arctic Spas®.

Arctic Spas® expressly excludes warranty coverage on splitting, fading or warping of the cedar or no maintenance cabinet beyond the date of delivery. Any damage resulting from handling of the cedar or no maintenance cabinet is excluded from this warranty. This warranty will not cover any labour for WIFI/Bluetooth connection assistance/issues, onSpa® App initialization & connection assistance/issues from a smartphone, or assistance with actually connecting any of these devices.

Bear Essential Class
Warranty see pages: 135 - 136

Core Series
Warranty see pages: 137 - 138

ONSPA AND WEB CONNECT USER GUIDE

1 onSpa and Web Connect User Guide

This User Guide provides the Spa owner information on how to connect their Arctic Spa to their home network and the My Arctic Spa Server allowing the Spa owner access to the full benefits of onSpa, Web Connect and owning an Arctic Spa.

There are three steps involved in the complete connection process:

1. Download the free Arctic Spas App, onSpa for your device, such as smart phone or tablet from your App Store.
2. Connect your home network to your spa either by Ethernet over Power (EoP), WIFI Extender or LAN Cable. Once this is achieved onSpa will function through your device allowing you to control your spa with your device locally (within your home network WIFI range).
3. Connect your Spa to the My Arctic Spa Server through Web Connect which is achieved by opening a free User Account on the myarcticspa.com Web Page and registering your Spa against the User Account raised. Once this is achieved, onSpa will function through your device or computer allowing you to control your spa with your device or computer anywhere in the world where you have internet connection.

Note: If your Arctic Spa is not optioned with WIFI capability for onSpa, any Arctic Spa can be upgraded to have the required onSpa components installed. Please contact your Arctic Spas Dealer and provide your Dealer with the Serial Number of your Arctic Spa.

OnSpa and Web Connect Overview Connection Flowchart

The following flowchart provides an overview of the onSpa and Web Connect connection process.

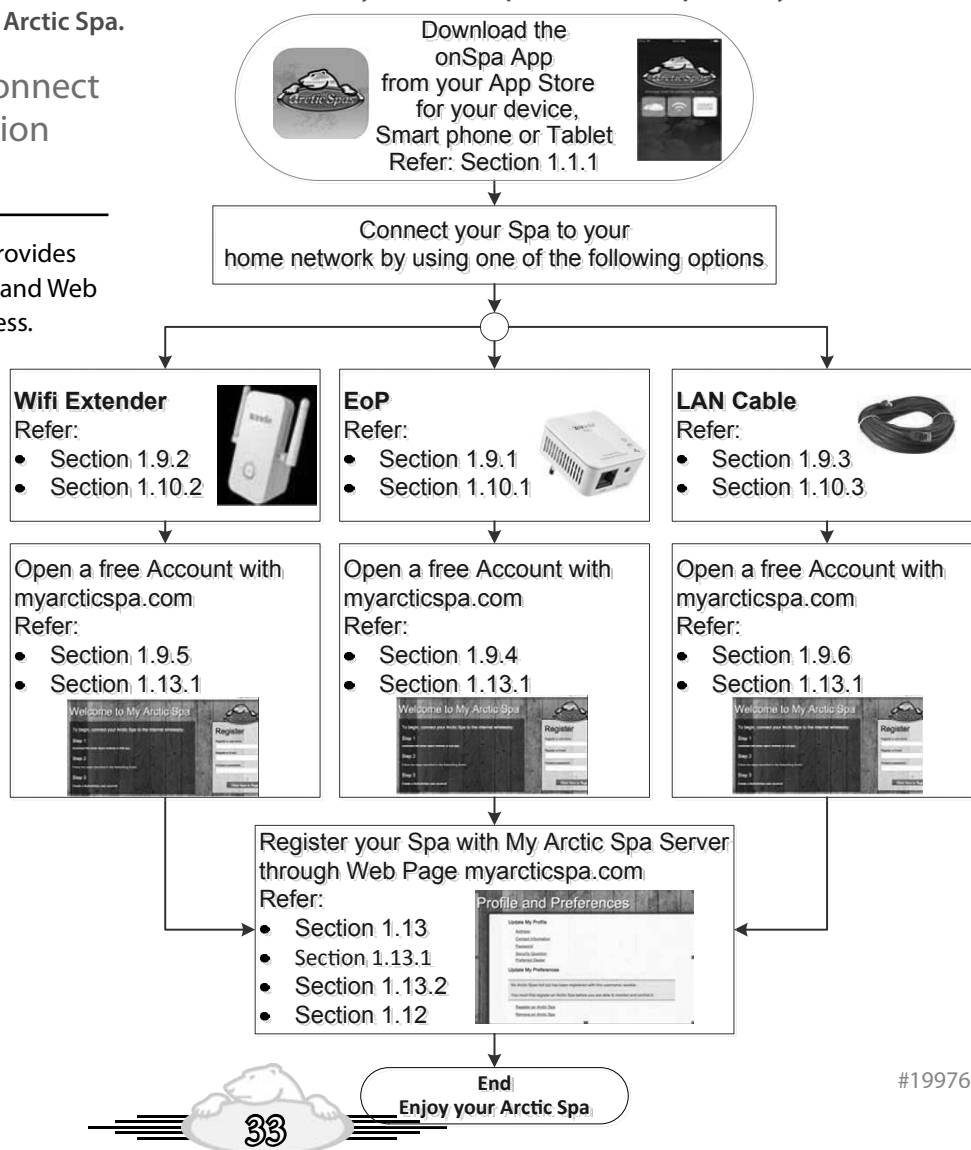

1.1 Arctic Spas App?

The onSpa App provides total control of your Arctic Spa remotely.

Allows you to:

- Activate the jets, blower(s), lights, fogger, Spaboy Boost.
- Check and adjust water temperature, filtration, ozone, onzen, spaboy.
- Set and activate power management, view your spas power consumption detail.
- Play Music.
- Lock controls.
- Access Spa owner manuals, quick reference cards, user guides and lots more.
- Access new features as added.

1.1.1 Downloading the App

Go to your App Store and download the free Arctic Spas App

The App is available for:

- Apple devices.
- Android devices.

The App also has a demo mode allowing you to play with the App prior to connecting your Spa to onSpa.

1.2 What is onSpa?

The most advanced control system available for Spas on the market.

Any smart-phone, tablet and computer can function as the Spas control centre with the OnSpa App.

1.3 What is Web Connect?

Web Connect is the most ambitious extension of the onSpa system, allowing an EcoPack equipped Arctic Spa to establish a connection directly to the Internet. In doing so, the spa owner can log into the spa anywhere there is an Internet connection, and from the convenience of a smartphone, tablet or computer can monitor and adjust all major functions of the spa. Web Connect allows the user to have choice within this functionality, connect via the Cloud, WiFi or via the myarcticspa.com website.

Note: Before you can utilize Web Connect you must first connect your Spa to your Home Network, either by EoP, WIFI Extender or LAN Cable.

1.4 What Are The Benefits of Web Connect?

A) Adjust basic spa functions, such as:

1. Turn pumps on or off
2. View current status of Heating cycle, Filtration cycle and Economy Mode:
3. View current, and adjust temperature
4. Turn lighting systems on/off or cycle colour and patterns

B) Adjust Higher level functions such as:

1. Adjust filtration cycle frequency and duration
2. Adjust Peak Ozone system
3. Adjust Onzen Salt Water system output.
4. Set power management functions.
5. Monitor your spas power consumption
6. Monitor Spaboy water chemistry parameters

C) Reference Functions, such as access:

1. Owners Manuals.
2. Onzen Saltwater Manual.
3. Spaboy Manual.
4. Troubleshooting Guide, brochures and Quick Reference Cards (QRC).

1.5 What is Ethernet Over Power?

Power line technology allowing existing electrical wiring to deliver electrical power and transmit network data in a single power line without the need to run data cabling.

1.6 What is WIFI Extender?

A Wi-Fi Extender, sometimes called a range expander, is a type of wireless repeater used to expand the reach of a wireless LAN.

1.7 What is a Home Network Connection Through LAN Cable?

An Ethernet cable which is directly connected to the RJ45 Port on your Spas Processor Card and the other end connected to an RJ45 Port on your Home Router. Where a new power cable needs to be run from your home to your Spa, it is also a good opportunity to run an Ethernet cable to your Spa at the same time. Doing so achieves the best method of connecting your home network to your Spa.

1.8 What is myarcticspa.com?

Myarcticspa.com is a Web based after sales support system designed and built by Arctic Spas especially for Arctic Spa owners that are utilizing onSpa.

Myarcticspa.com through Web Connect allows the spa owner to log into their spa anywhere in the world where they have Internet connection, and from the convenience of a smartphone, tablet or computer can monitor and adjust all major functions of the spa. Web Connect allows the user to have choice within this functionality, connect via the Cloud, WiFi or via the myarcticspa.com website.

Web Address is: www.myarcticspa.com



1.9 How Does onSpa and Web Connect Work?

The following diagrams show how:

- onSpa interfaces with your device and Spas Global Eco Pak through Ethernet Over Power (EoP).
- onSpa interfaces with your device and Spas Global Eco Pak through WIFI Extender.
- onSpa interfaces with your device and Spa Global Eco Pak, through a LAN Cable which is directly connected to the RJ45 Port on your Spas Processor Card and the other end connected to an RJ45 Port on your Home Router.
- onSpa interfaces with your device/computer and Spas Global Eco Pak through Ethernet Over Power (EoP) anywhere in the world where you have WIFI access on your device or computer.
- onSpa interfaces with your device/computer and Spas Global Eco Pak through WIFI Extender anywhere in the world where you have WIFI access on your device or computer.
- onSpa interfaces with your device/computer and Spa Global Eco Pak, through a LAN Cable which is directly connected to the RJ45 Port on your Spas Processor Card and the other end connected to an RJ45 Port on your Home Router.

1.9.1 onSpa Interface Through EoP

The following diagram reflects onSpa interface through a EoP.

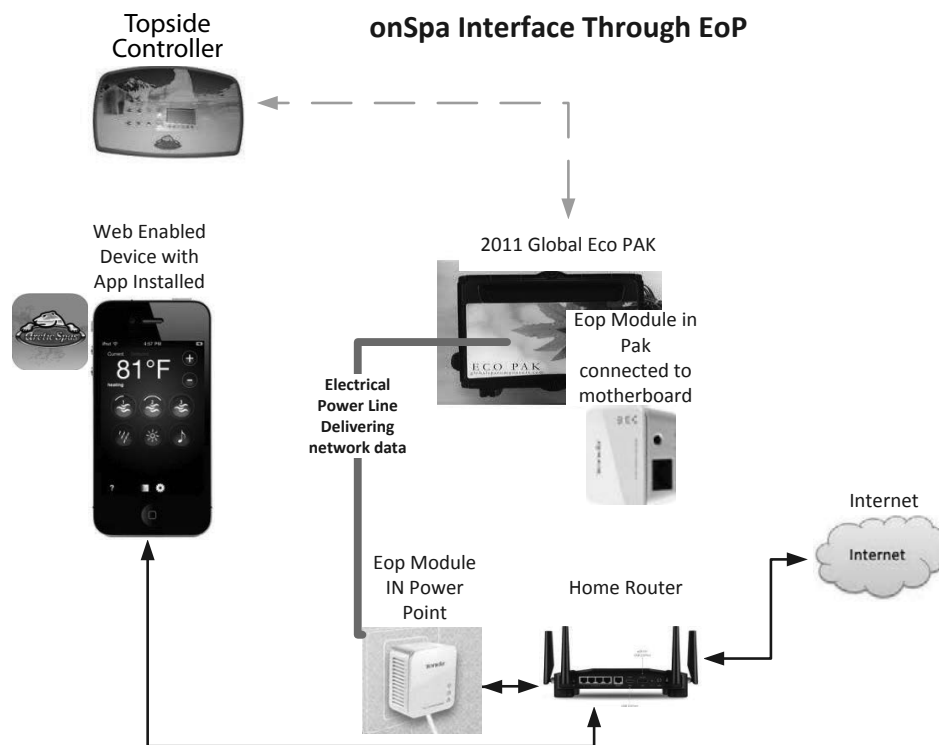

1.9.2 onSpa Interface Through WIFI Extender

The following diagram reflects onSpa interface through a WIFI Extender

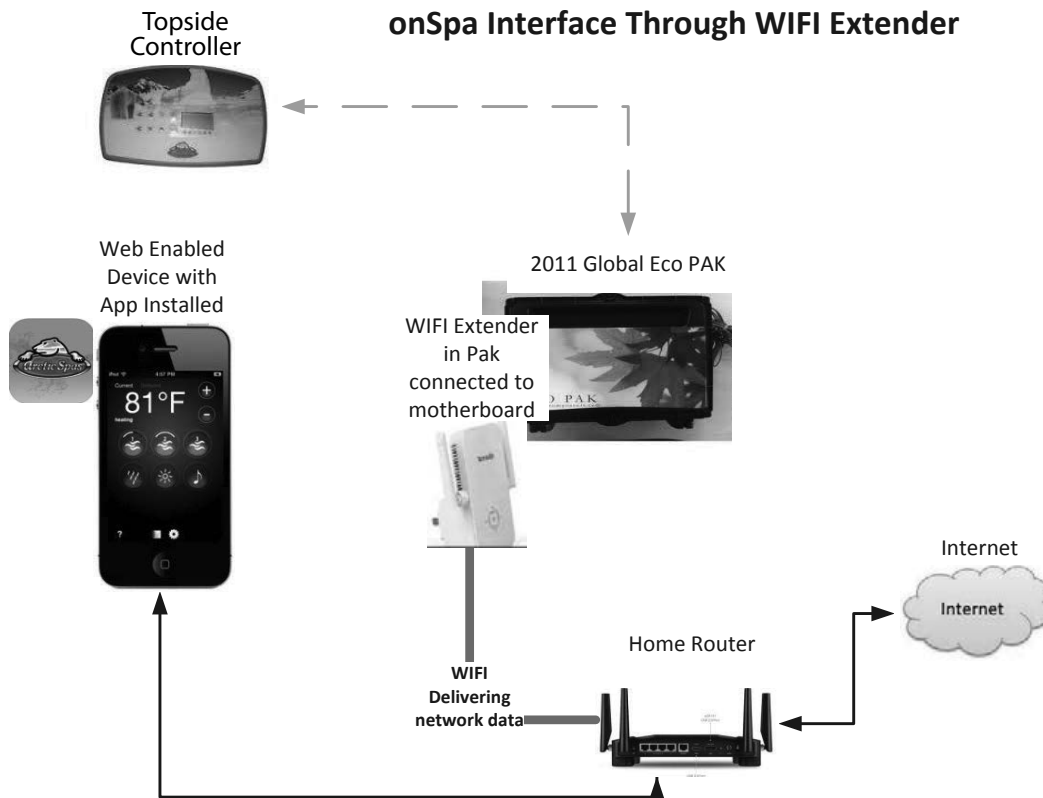

1.9.3 onSpa Interface Through LAN Cable

The following diagram reflects onSpa interface through a LAN Cable connected to the Spas Processor Card and home Router.

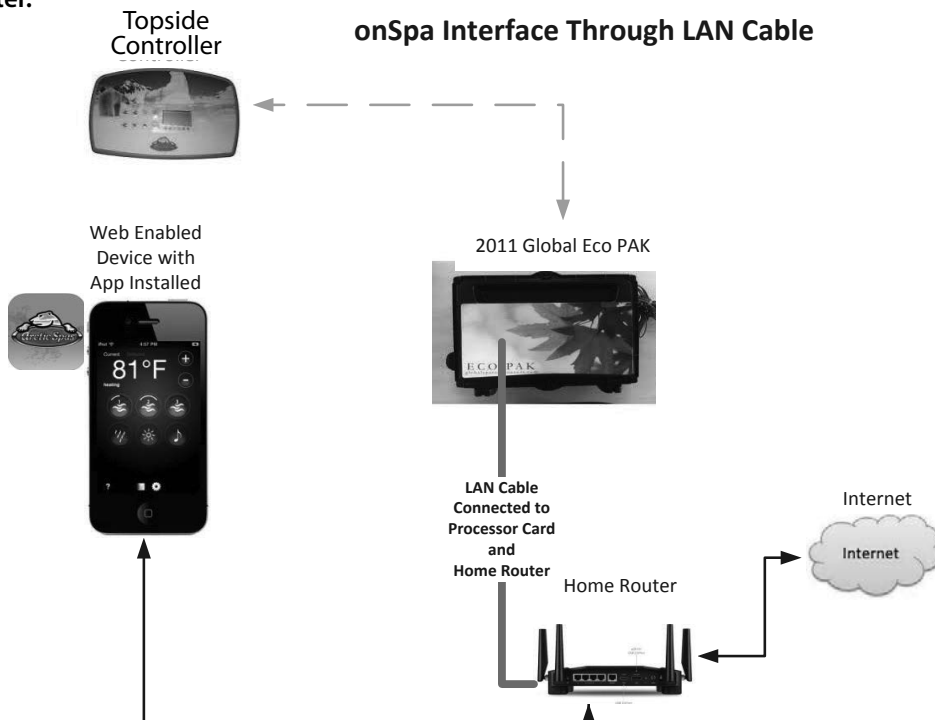

1.9.4 Web Connect Interface Through EoP

The following diagram reflects onSpa interface with Web Connect through EoP.

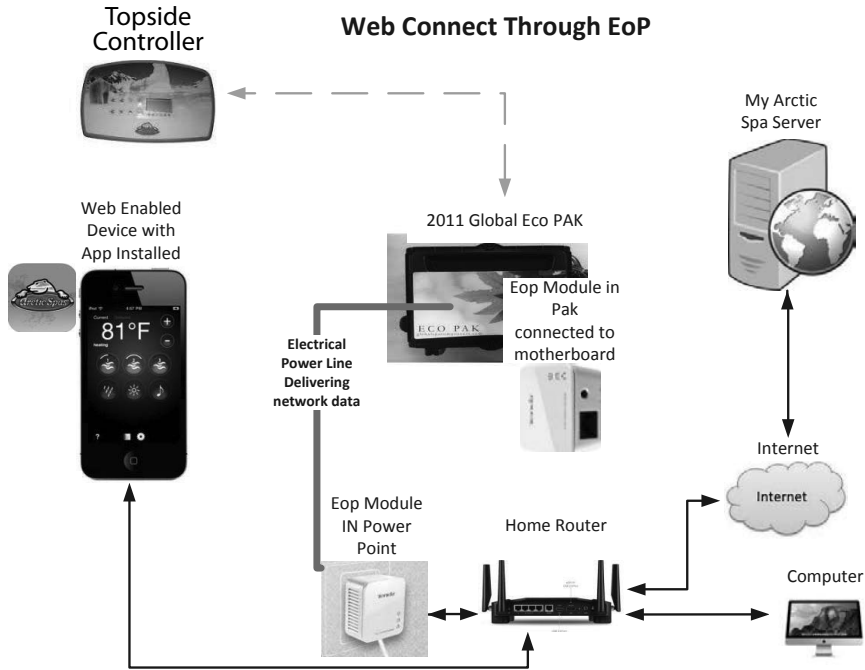

1.9.5 Web Connect Interface Through WIFI Extender

The following diagram reflects onSpa interface with Web Connect through WIFI Extender.

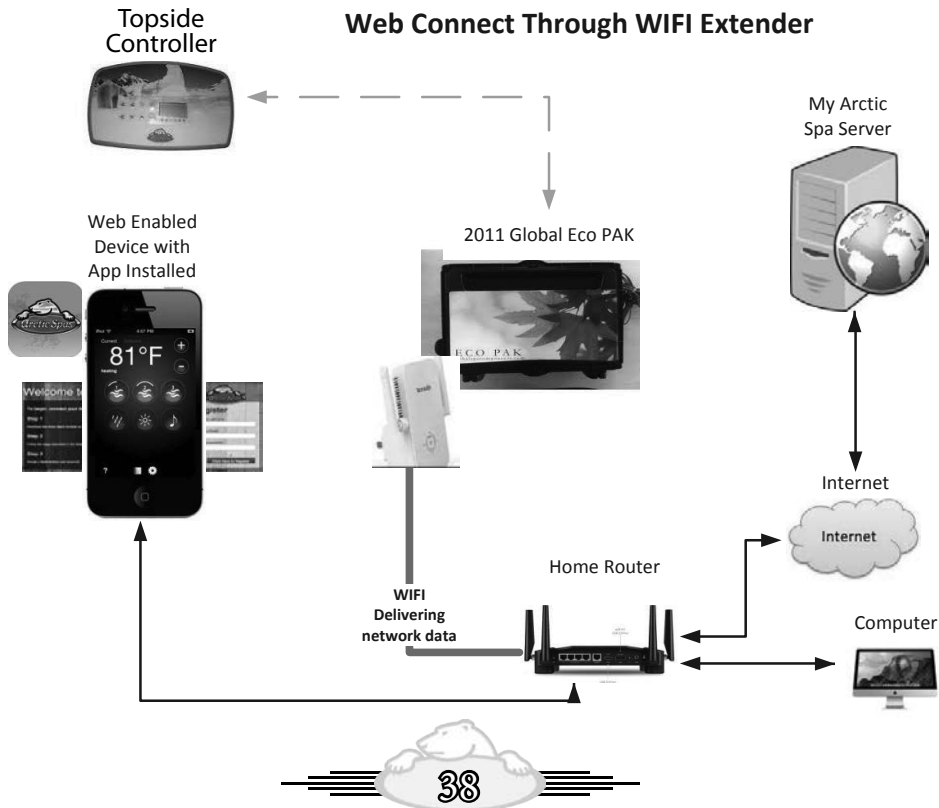

1.9.6 Web Connect Interface Through LAN Cable

The following diagram reflects onSpa interface with Web Connect through a LAN Cable connected to the Spas Processor Card and home Router

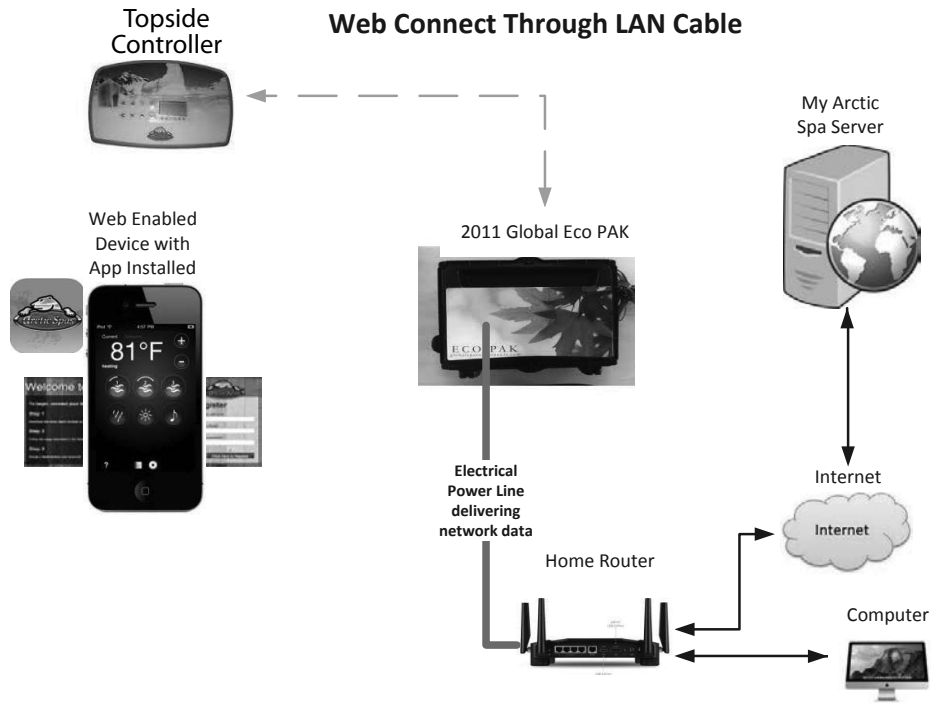

1.10.2 onSpa QRC Through WIFI Extender Flowchart

The following flowchart shows how to connect onSpa through WIFI Extender.

The following Supportive Video Link may also assist you with this process:
<http://www.arcticspas.com/support/how-to-videos/how-to-connect-with-a-tenda-wifi-extender/>

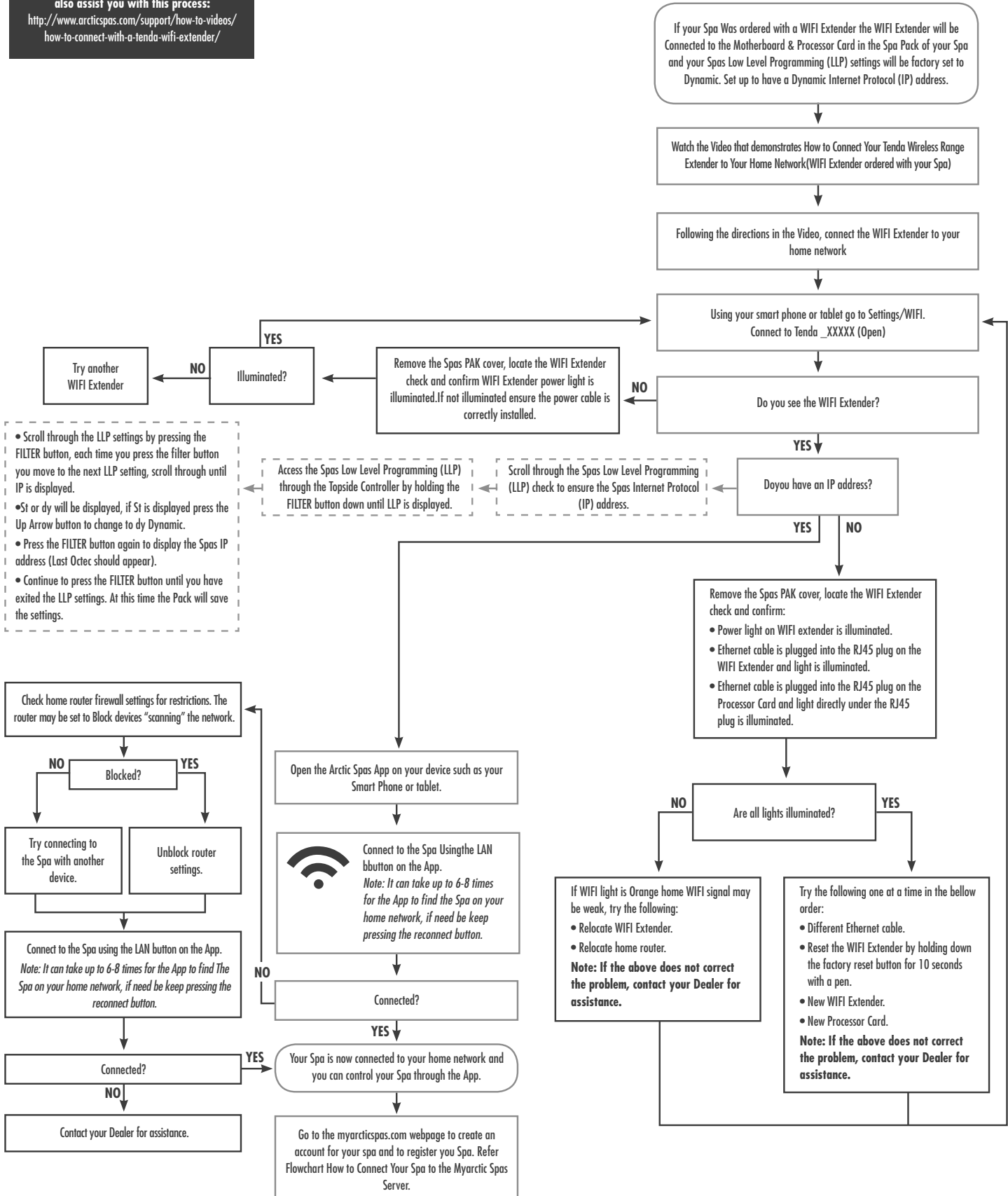

1.10.3 onSpa QRC Through LAN Cable Flowchart

The following flowchart shows how to connect onSpa through connecting a LAN cable to the RJ45 Port on your Spas Processor Card and the other end connected to an RJ45 Port on your Home Router.

The following Supportive Video Link may also assist you with this process:
<http://www.arcticspas.com/support/how-to-videos/how-to-connect-with-direct-ethernet-connection/>

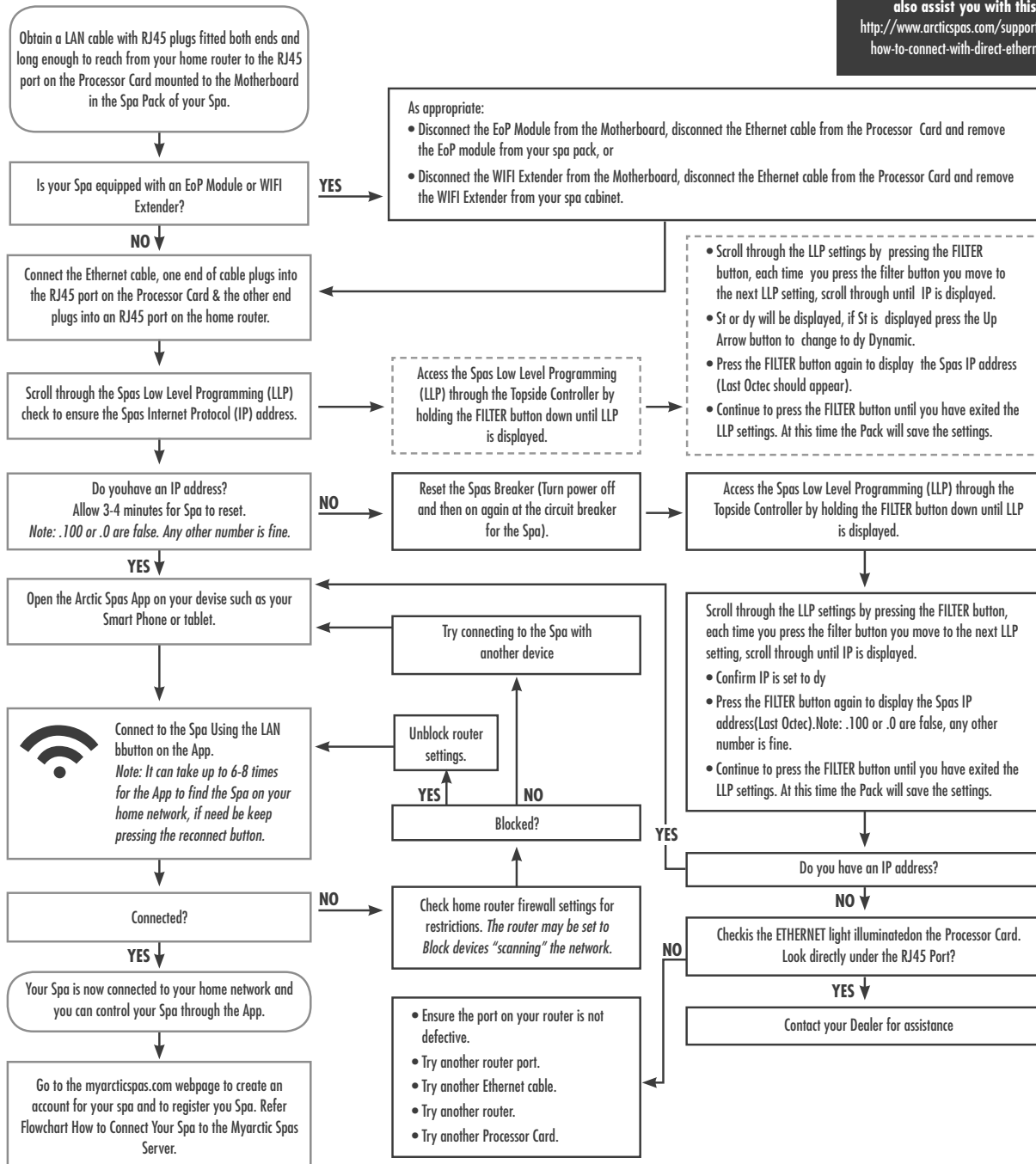

1.11 Connect your Spa to the Home Network

You must first connect your spa to your home network, either using an EoP, WIFI Extender or LAN Cable through your web device such as Smart Phone or tablet.

Refer Section 1.10 onSpa Quick Reference Charts (QRC)

- Section: 1.10.1 onSpa QRC Through Ethernet Over Power (EoP) Flowchart.
- Section 1.10.2 onSpa QRC Through WIFI Extender Flowchart.
- Section 1.10.3 onSpa QRC Through LAN Cable Flowchart.

1.12 Low Level Programming (LLP) Overview

The following steps show how to access Low Level Programming (LLP) through your Spas Topside Controller to ensure your Spas IP Address is set to Dynamic (dy) and your Spa has been assigned a valid IP Address.

Steps to Access LLP to ensure your Spas IP Address is set to Dynamic (dy) and your Spa has been assigned an IP Address



Step 1. Access Low Level Programming through your Topside Controller

Press and hold down the FILTER button until LLP is displayed in the display window (approx. 20 Seconds. The display will first show Filter settings. Set, continue to hold the button down until LLP is displayed.

Note: For a 5 pump spa (Epic) press and hold down PUMP 5 button.



Step 2. Scroll through LLP Settings until IP is Displayed

Scroll through the LLP settings by pressing then removing your finger from the FILTER button until IP is displayed, IPst or IPdy will be displayed. To change to IPdy press the Up Arrow button on the Topside Controller.



Step 3. Scroll to next LLP Setting to view the Spas IP Address Assigned as Displayed on the Topside Controller.

Scroll to the next LLP setting by pressing the FILTER button to display the IP Address assigned to the Spa.

Note: .0 or .100 may not be a valid IP Address.

1.12 (continued)

Steps to Access LLP to ensure your Spas IP Address is set to Dynamic (dy) and your Spa has been assigned an IP Address



Step 4. Scroll to the end of the LLP Settings to save/exit the settings.

Scroll to the end of the LLP setting by pressing the FILTER button until you reach the end of the LLP settings. The Spa will then perform a reboot.

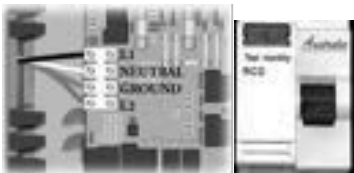

Step 5. Turn off the Electrical Power to the Spa

Turn of the power to your spa at the spas breaker.

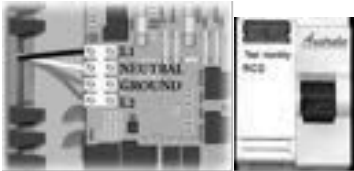

Step 6. Turn on Electrical Power to the Spa

Turn on the power to your spa at the spas breaker.

Wait until the spa reboots fully.



Step 7. Confirm Spa has been assigned valid IP Address

Confirm Spa has been assigned a valid IP Address by entering LLP setting and scrolling through the LLP settings until the Spas IP address is displayed.

Note: .0 or .100 may not be a valid IP Address.



Step 8. Scroll to the end of the LLP Settings to save/exit the settings.

Scroll to the end of the LLP setting by pressing the FILTER button until you reach the end of the LLP settings. The Spa will then perform a reboot.

1.13 How to Connect Your Spa to the My Arctic Spas Server (Web Connect)

Once you have connected your Spa to your Home Network, ether by EoP WIFI Extender or LAN Cable you can take full advantage of onSpa by establishing a Web Connection to the My Arctic Spa Server.

To do this, you must first open a free account with myarcticspa.com and register your Spa on the My Arctic Spa server which is linked to the myarcticspa.com webpage.

1.13.1 Web Connect Flowchart

The following flowchart shows how to open a free account with myarcticspa.com and register your Spa on the server linked to the myarcticspa.com webpage. **Once completed, onSpa will be fully functional through Web Connect**

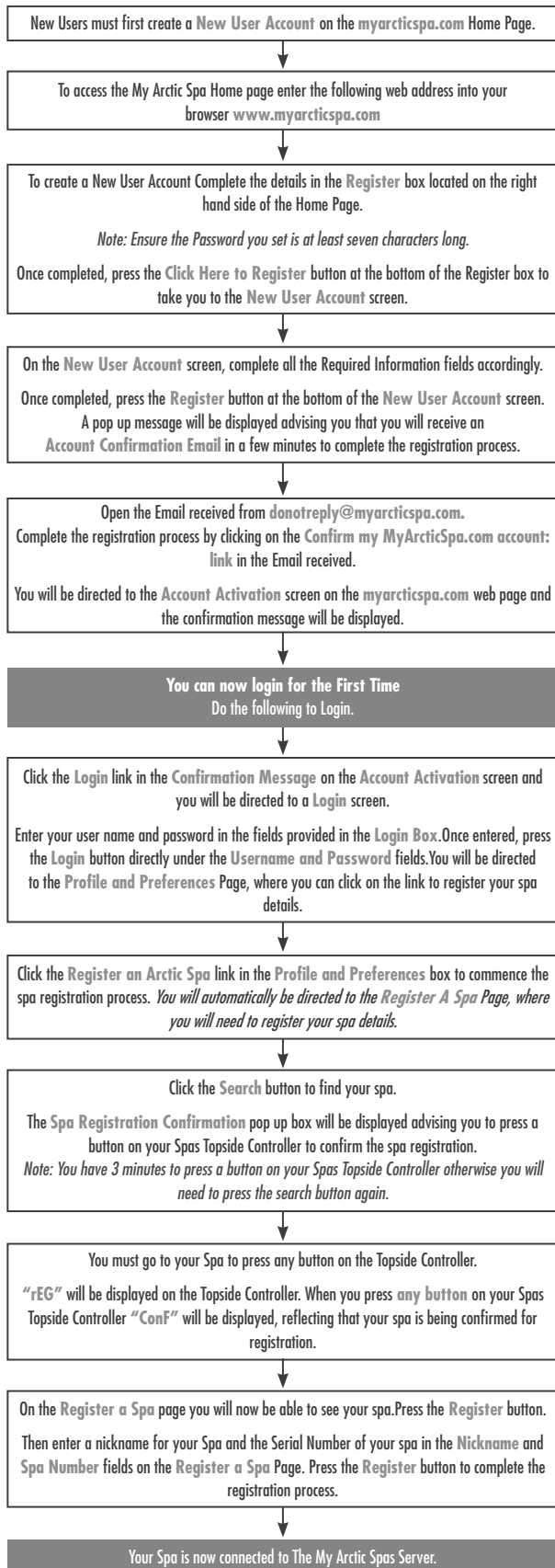

The following **Supportive Video Link** may also assist you with this process:
<http://www.arcticspas.com/support/how-to-videos/how-to-connect-arctic-spas-to-the-my-arctic-server/>

NOTE: Once you have logged in for the first time and registered your spa details within myarcticspa.com, logging into myarcticspa.com is achieved from accessing the My Arctic Spa home page.
Login by entering your user name and password in the fields on the upper right hand side of the home page.
Once entered press the **Login** button directly under the Username and Password fields. Once logged in, My Arctic Spa will automatically open your personal My Arctic Spa page.

NOTE: You will receive a prompt to reflect that your spa must be connected to the Internet (Your Home Network). **You must have first connected your spa to your home network** using the App on your device such as a Smart Phone or tablet. This will have been achieved with a WIFI connection using either EoP, WIFI Extender or LAN connection.

The Spas Serial No. can be located on the **Metal Compliance Plate** mounted to your spa just above the Bottom Rail and between two doors. You only need and register the number portion of the complete Serial No. Eg Spa Serial No. AX16KX178910, 17890 is the portion of the Serial No. required to be recorded.

Through myarcticspa.com you now have direct access to all your Spas Functions and Settings from anywhere in the world where internet access is available through your smart phone, tablet or computer.

1.13.2 Register Spa With My Arctic Spa

You will now need to register your spa through the internet with the My Arctic Spa Server through Web Page www.myarcticspa.com.

Myarcticspa.com is a Web based after sales support system designed and built by Arctic Spas especially for Arctic Spas owners allowing owners access to the full benefits of owning an Arctic Spas Spa.

The My Arctic Spa Server has been designed to receive data from your spa over the internet through your home network system. The data is logged and saved to the My Arctic Spa Server on a continual basis.

The web address is: www.myarcticspa.com

Refer Section 1.11 My Arctic Spa for registration details.

1.14 My Arctic Spa

The following is a brief outline of My Arctic Spa.

Myarcticspa.com is a Web based after sales support system designed and built by Arctic Spas especially for Arctic Spas owners allowing owners access to the full benefits of owning an Arctic Spas Spa.

The My Arctic Spa Server has been designed to receive data from your spa over the internet through your home network system. The data is logged and saved to the My Arctic Spa Server on a continual basis.

My Arctic Spa has been designed to:

- Receive data from your spa over the Internet through your home network which has been connected to your spa. The data is logged and saved on the My Arctic Spa Server on a continual basis.
- If Spaboy is equipped in your Spa, send automated email notifications to the Spa owner when the pH level of the spas water is outside the required range (out of balance).

The following pages make up the My Arctic Spa Web site:

- Home.
- Register.
- Login.
- Settings.
- Documentation.
- Error Codes.
- About.
- Profile.
- Diagnostics.
- Logout.

As you can see from the above, My Arctic Spa clearly places Arctic Spas owners another milestone ahead of owners of other brand spas.

Register and enjoy the experience.

1.14.1 Home Page

To access the My Arctic Spa Home page enter the following web address into your browser.

www.myarcticspa.com

For a new user, the user must first create a new user account by completing the details in the Register box located on the right hand side of the Home Page.

For a registered user, click on the Login button located on the upper right hand side of the **Home Page**.



1.14.2 New User Registration

For a new user, to create a user account complete the details in the **Register** box located on the right hand side of the Home Page.

Note: password must be at least seven characters long.

Once completed, press the Click Here to **Register** button at the bottom of the Register box on the Home Page.



You will now have been directed to New User Account screen.

Complete all the Required information fields accordingly.

Once completed, press the **Register** button at the bottom of the New User Account screen.

My Arctic Spa: New User Account – Screen Shot



The screenshot shows a registration form titled "New User Account" with the My Arctic Spa logo in the top right. The form includes the following fields and instructions:

- * Required Information**
- Enter a username: wookie
- Choose a password: []
- Confirm password: []
- Enter your e-mail address: viliela@optusnet.com.au
- Confirm e-mail address: []
- Please select your Security Question and enter the answer in the field below.
- For your convenience we have created a list of Security Questions. You also have the option of entering your own questions, however we recommend you use the ones listed in the dropdown menu.
- Security Question: Select a question [1]
- Answer: []

You will then receive an Account Confirmation Email from My Arctic Spa.

Once you receive the email complete the registration through confirming your email address by clicking on the LINK in the email received.

My Arctic Spa: Login Box Account Activation – Screen Shot



The screenshot shows a confirmation message titled "Account Activation" with the My Arctic Spa logo. The message reads: "wookie account has been successfully activated. You may now login to MyArcticSpa.com."

You will be directed to the Account Activation screen on the myarcticspa.com Web page, and the confirmation will be displayed.

1.14.3 Login First Time

Before you login for the first time you should first ensure your Spa has already been connect your home network.

You can now login by clicking the login link on the Account Activation screen and entering your user name and password in the fields provided in the Login box.

You will automatically be directed to the Profile and Preferences Page, where you will need to register your spa details.

Note: Once you have logged in for the first time and registered your Spa details within myarcticspa.com, logging into myarcticspa.com is achieved from accessing the My Arctic Spa home page Log in by entering your user name and password in the fields on the upper right hand side of the home page. Once logged in, My Arctic Spa will automatically open your personal My Arctic Spa Page.

My Arctic Spa: Login Box – Screen Shot



The screenshot shows a login form titled "Login" with the My Arctic Spa logo. The form includes the following elements:

- Sign into MyArcticSpa.com with your account.
- Username: []
- Password: []
- Remember Me
- [Forgot password?](#)
- [Forgot username?](#)
-
-
- [Resend account confirmation email](#)

1.14.4 Register an Arctic Spa

To register your Arctic Spa details click the **Register an Arctic Spa** link in the **Profile and Preferences** box.

You will receive a prompt to reflect that your spa must be connected to the Internet (Your Home Network). Click the Search button to find your spa. The **Spa Registration Confirmation** pop up box will be displayed advising you to press a button on your Spas Topside Controller to confirm the spa registration.

You must go to your Spa and press any button on the Topside Controller.

'**REG**' will be displayed on the Topside Controller. When you press any button on your Spas Topside Controller "**Conf**" will be displayed, reflecting that your Spa is being confirmed for registration.

On the **Register a Spa** page you will now be able to see your Spa.

Press the **Register** button.

Then enter a nickname for your Spa and the Serial Number of your Spa in the **Nickname** and **Spa Registration** fields on the **Register a Spa** Page.

Press the Register button to complete the registration process.

Your spa will now be connected to the My Arctic Spa server

My Arctic Spa: Profile and Preferences – Screen Shot

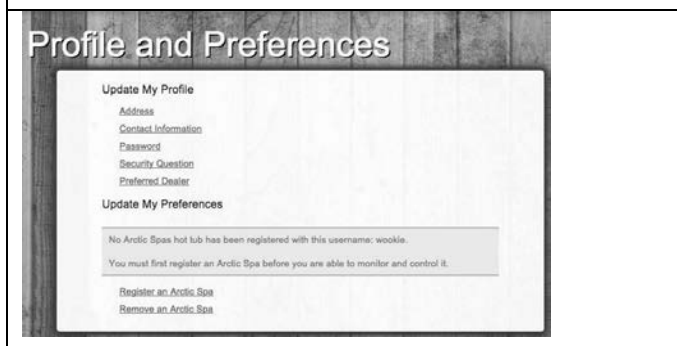

1.14.5 Login

Once you have logged in for the first time and registered your spa details within My Arctic Spa, logging into My Arctic Spa is achieved from accessing the My Arctic Spa home page. Login by entering your user name and password in the fields on the upper right hand side of the home page.

Once entered press the **Login** button directly under the Username and Password fields.

Once logged in, My Arctic Spa will automatically open your personal **My Arctic Spa** page.

Note: If you have forgotten your password you can press the Forgot Password button to re-establish your password.

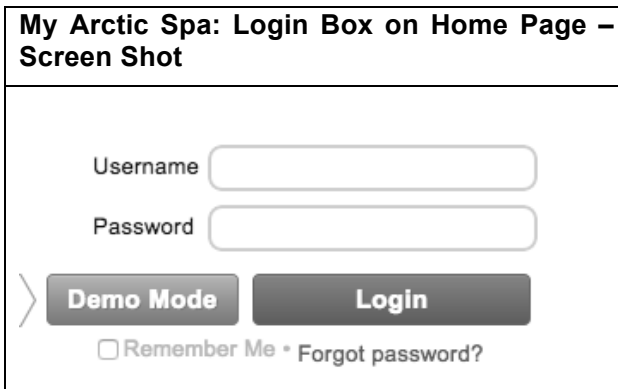

1.14.6 My Arctic Spa

Once you have logged in, My Arctic Spa will have automatically directed you to, your **My Arctic Spa** page.

If your spa is connected to the internet through your home network you can see if your spa is in use, adjust the temperature and turn on and off components if desired, see ORP and pH levels, etc

From this page you are able to explore the My Arctic Spa web pages by clicking the desired tab along the horizontal tool bar.



1.14.7 Settings

Click on this tab to access the Settings page.

From this page, you can see your spas pH and ORP readings, see if your Spa Boy System is currently producing Sanitizer (Sanitizing) adjust the following settings of your spa:

- Filtration.
- Spa Boy.
- Spa Boy Status.
- Peak II Ozone or Peak 1 Ozone if your spa is equipped.
- Power Management.
- Firmware Upgrade
- Onzen

Note: The above displays will vary from spa to spa depending on the options that your spa is equipped with.

My Arctic Spa: Settings – Filtration Screen Shot



Filtration

The Filtration dashboard allows you to easily adjust filtration cycles and run times.

My Arctic Spa: Settings – Spa Boy Status Screen Shot



Spa Boy Status

If your spa is optioned with Spa Boy, the dashboard displays:

- Your spa waters Chlorine and pH levels, which is divided into three ranges, Low, Ok, High.
- Battery Status Indicator that displays Spa Boy Salt Cell remaining life. For this function your spas Firmware must be 3.30 or higher.
- Indication light to reflect if the Spa Boy System is currently operating or not operating.
- Boost Button to manually activate the Spa Boy System for 1 hour. Boost button can be activated in cases when you know you are going to have a heavy bather load.

Onzen Status

If your spa is optioned with Spa Boy and Onzen is set to 1 in LLP the Onzen Status Screen will display your spas water actual pH and ORP readings.



My Arctic Spa: Settings

Onzen Status Screen Shot



1.14.8 Documentation

Click on this tab to access the Documentation page.

This page provides you easy access to:

- Owners manual.
- Onzen.
- Spa Boy Owners Manual.
- Other cool stuff.
- Power Management.
- Quick Reference Cards.

My Arctic Spa: Documentation – Screen Shot



1.14.9 Error Codes

Click on this tab to access the Error Codes page.

This page provides you quick access to error code descriptions, possible causes and solutions for error codes that will be displayed on your spas topside controller, in the unlikely event of a system warning linked to a possible component fault, such as:

- Flow switch error - FLC.
- Flow switch error - FLO.
- High limit error - HL.
- High limit temp probe error - HL.
- Temp probe error - PRR.

Click on the error code to obtain further details of each error code. There is also a link to the Detailed Topside Codes.

My Arctic Spa: Error Codes – Screen Shot

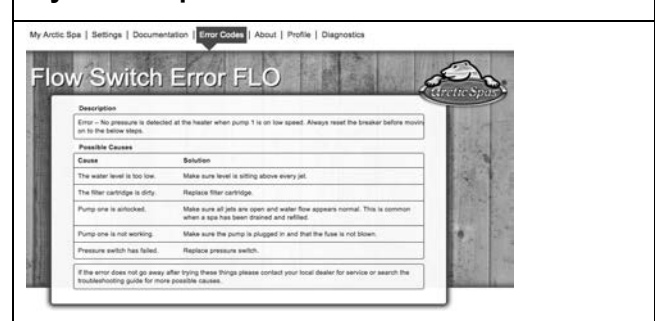

1.14.10 About

Click on this tab to access the About page.

This page displays the following details about your spa:

- Firmware version load.
- Hardware version.
- Product ID.
- Spa serial number.

My Arctic Spa: About – Screen Shot

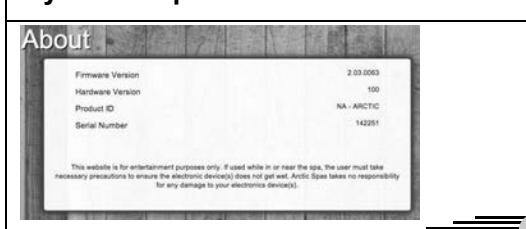

1.14.11 Profile

Click on this tab to access the Profile page.

This page is used to:

- Update your personal details such as email and password.
- Update your preferences such as register and remove an Arctic Spa from My Arctic Spa.

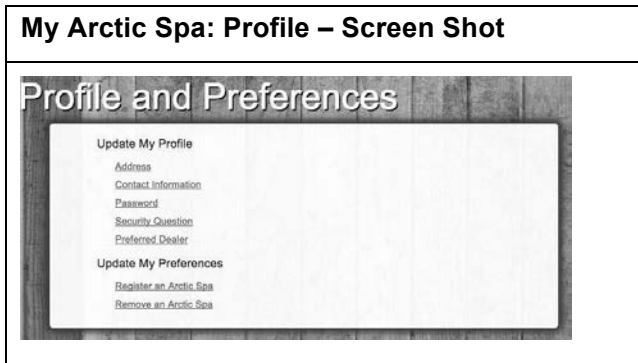

1.14.12 Diagnostics

Click on this tab to access the Diagnostics page.

This page is used to access the data that has been transmitted from your spa to My Arctic Spa. Data such as, but not limited to the following is captured:

- Spa Boy Power Consumption.

The data can be used by the Spas owner to determine and track their spas power consumption.

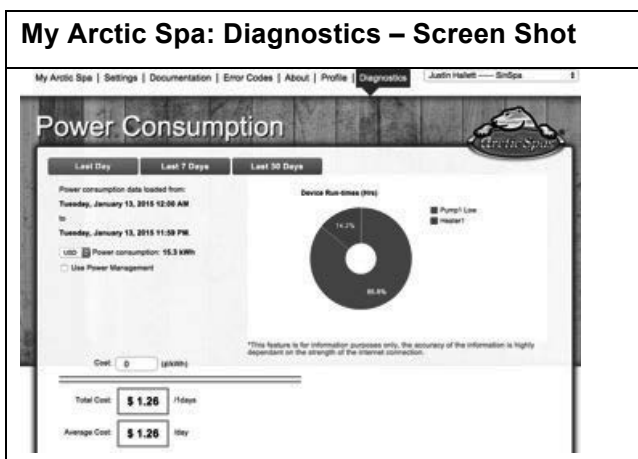

1.14.13 Logout

To logout of My Arctic Spa press the Logout button on the horizontal tool bar in the right hand upper corner of the screen.

Once out, enjoy your spa!

SPA BOY OWNERS MANUAL

1.1 Obtaining Technical Data For Your Spa

To ensure you have the current appropriate technical data for your spa it is recommended that you obtain such data from your authorised retailer or from the Arctic Spas Web Site <http://arcticspas.com>.

1.2 Revision Summary

The table below identifies all the significant changes made to this manual through the August 2017 revision.

Revision Summary for Revision 1 – August 2017

Section	Revision Details
Global Change	Salinity dosage levels have been revised. Knowledge gained through research and development identified that Spa Boy performs at its optimum with a salinity level between 2000ppm – 2500ppm
1.15	Included the entire OnSpa User Guide instructions
1.16	Added Question 15 covering Spa Boy Boost Button and revised questions 1,3,5,6,7,9,10,11 updated other questions
1.17	Updated the Spa Boy Maintenance schedule Quick Reference Card
1.18	Included the Spa Boy low ORP detected troubleshooting flowchart

NOTE: If your spa is equipped with an Onzen system you will need to refer to the Onzen Technical Guide.

1.3 What is Spa Boy?

Spa Boy is an advanced salt water maintenance system designed to data log pH and ORP readings and self manage the ORP level within the specified range.

1.4 What Does Spa Boy Do?

- Data log spa water pH and ORP readings.
- Maintains ORP within the specified range by automatically producing sanitizer (Chlorine) agents.
- Displays current ORP and pH levels of your spa water.
- Softens water.
- Clarifies water.

1.5 What Are The Benefits of Spa Boy?

- Automatically maintains sanitizer (Chlorine) within the specified ORP range.
- Displays current ORP and pH levels of your spa water.
- Takes the guess work out of calculating how much Arctic Pure, Salt Water Balance is required to add to your spa water to lower the pH level within the required range.
- Makes skin feel soft and smooth.
- Makes water look sparkling clean.
- Reduces contact with harsh chemicals.
- Dramatically reduces time and money needed to maintain spa water.
- Reduces impact to the environment:
 1. Fewer trips to the spa store for supplies and having your water tested.
 2. Less packaging wasted on chemical containers.
 3. Less industrial waste produced making spa chemicals.

1.6 How Does Spa Boy Work?

- Consumer registers their spa on the My Arctic Spa web based after sales support system.
- Arctic Pure Natural Mineral Sea Salt Blend is added to the spas water when the spas has been filled with water and water balanced.
- An ORP/pH probe is fixed into the foot well area of your spa, which sends a signal to the Spa Boy Generator and through the Spa Boy Communication Cable connects to the Global Eco PAK. The Global Eco PAK can then establish a two-way communication channel between the Global Eco PAK and myarcticspa.com
- Spa Boy data logs the spa water pH and ORP levels for the Technician to view..
- Spa Boy automatically produces and maintains sanitizer (Chlorine) within the specified ORP range (545-550mV).
- Spa Boy displays current ORP and pH levels of your spa water within My Arctic Spa.
- As required the consumer adds the required amount of Arctic Pure Salt Water Balance to keep the pH within the required range.





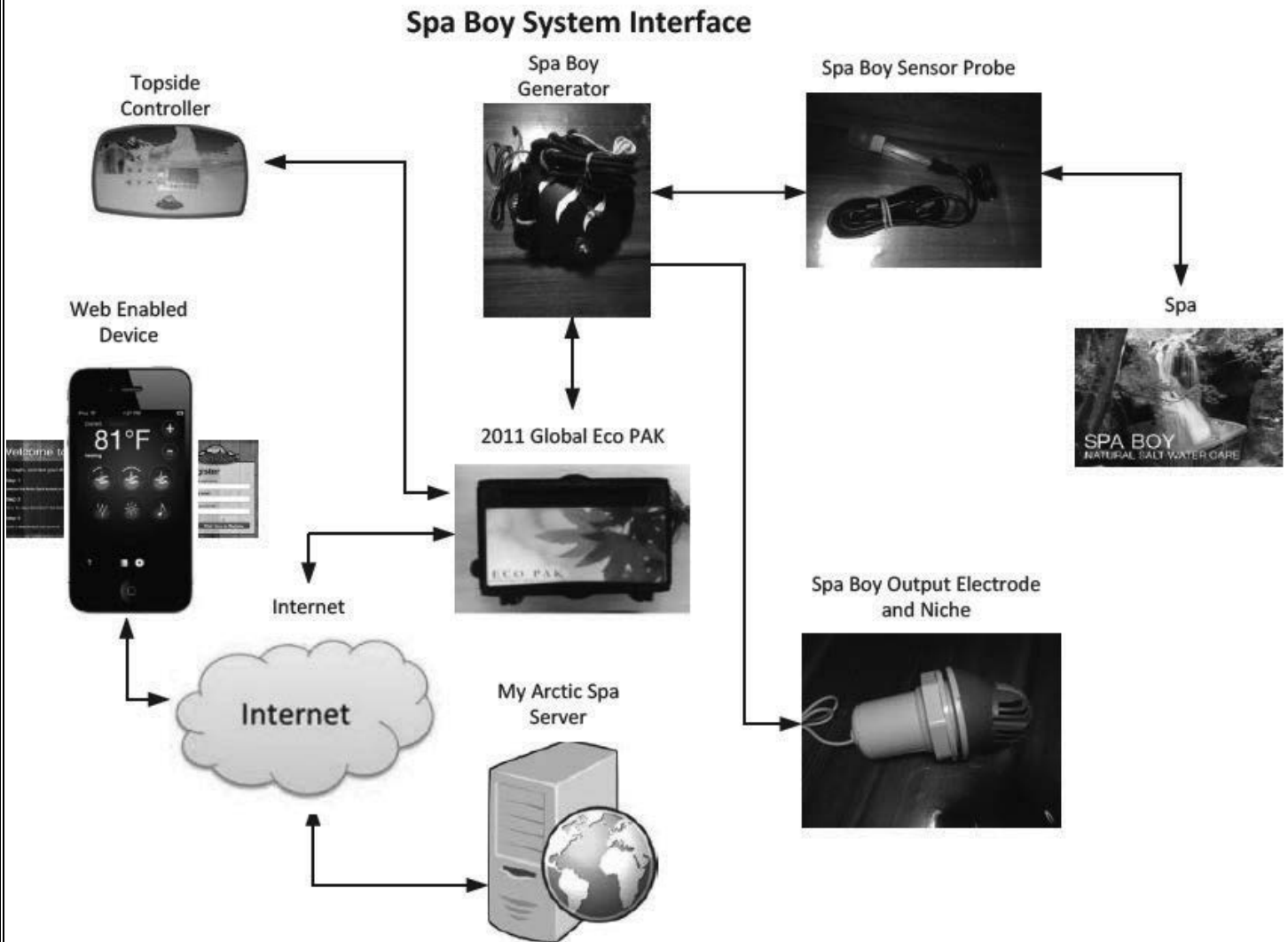



1.6.1 Spa Boy System Interface

The following diagram reflects the Spa Boy System interface:

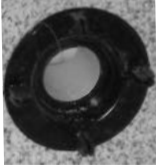

1.6.2 Spa Boy Main Components

The following table depicts the Spa Boy components referenced in this manual.

Term	Picture
2011 Global Eco PAK	
Spa Boy Generator with data communication cable	
Spa Boy Output Electrode	
Spa Boy Sensor	
Spa Boy Niche (Two piece the front section unscrews from the body section)	
Spa Boy Sensor Housing (Also known as Lippert Wallfitting Threaded)	
Spa Boy Housing Grate (Also known as Lippert Grate Threaded)	
Spa Boy Housing Plug	
Spa Boy Communication Cable	

1.7 Spa Boy Version Summary

Spa Boy Version 1 Revision 1 (R1)

When Arctic Spas first released their Onzen system back in 2009 the Arctic Spas vision was to provide the consumer with a spa that can self-manage water balance and sanitizer levels.

With the release of Spa Boy Version 1 R1, Arctic Spas have achieved their next milestone in realizing their vision.

Spa Boy Version 1 R1 can be easily upgraded (retrofitted) into a spa that currently does not have Spa Boy installed, providing the spa is equipped with a Global Eco PAK. The Global Eco PAK was released in 2011. Spas built prior to 2011 that are not equipped with the Global Eco PAK can also be upgraded with Spa Boy by replacing your Spa PAK with the 2011 Global Eco PAK. For upgrade details, consult with your Arctic Spas Dealer.



1.8 Spa Boy Version Table

The following table is used to track the release dates and provide a summary for any Spa Boy version releases.

SPA BOY VERSION	PRODUCTION RELEASE DATE	SUMMARY
Version 1	Jan 2015	Initial release

1.9 Spa Boy Version – Installed in Owners Spa

The following table provides for the owner to record the Spa Boy version details of their spa.

SPA BOY VERSION	SPA PRODUCTION DATE	SPA SERIAL NO.

1.10 How to Determine Spa Production Date

The Spa production date can be determined from the Spa Serial Number recorded on the Spa Identification Plate mounted on the cabinet usually under the topside controller.

Example : Spa Serial No. A10H131112

- The two digits following the first letter represent the year that the Spa was built
10 = 2010.
- The letter following the first two digits represent the month that the Spa was built
H = August.

**The 6 digit number represents the Spas Serial Number. 131112 = Serial Number.*

1.11 Definitions of Terms

TERM	DEFINITION
Spa Boy	Spa Boy is an advanced salt water maintenance system designed to data log pH and ORP readings and self manage the ORP level within the specified range (545-550mV).
Spa Boy Output Electrode	<p>Five plate platinum-iridium Titanium electrode - equipped salt cell converts the saltwater solution to sanitizer, and as this solution reverts back to its natural form (salt) after sanitizing. Unless large volumes of water are added to the spa you never have to add more salt. The five plate electrode plastic outer casing is grey in color.</p> <p><i>Note: When the Spa Boy System has activated the Output Electrode to generate sanitizer, the electrode gives off smoke effect.</i></p>
Spa Boy Output Electrode Version	Modification status of the electrode fitted to the spa.
Spa Boy Sensor	<p>pH and ORP sensor (probe) used to measure pH and chlorine (ORP) readings along with many other reading and transfer the readings to the My Arctic Spa web site.</p> <p>The Sensor is connected to the Spa Boy Generator and the Spa Boy Communication Cable from the generator is connected to the Global Eco PAK.</p>
Spa Boy Communication Cable	Cable that connects the Spa Boy Generator to the Global Eco PAK. The communication cable is used to establish continuous two-way communication between the Spa Boy System and myarcticspa.com.
Arctic Pure	Arctic Spas range of products developed especially for maintaining your spas water.
My Arctic Spa	<p>My Arctic Spa is a Web based after sales support system designed and built by Arctic Spas especially for Arctic Spas owners that have Spa Boy installed in their spa.</p> <p>My Arctic Spa has been designed to receive data from your spa over the internet through the spas Wi-Fi system. The data is logged and saved by My Arctic Spa on a continual basis.</p>
Calcium Hardness (CH)	<p>Calcium Hardness is a measure of the total amount of dissolved calcium salts in the water. CH helps determine how scaling or corrosive the water is. It is believed that calcium helps control the corrosive nature of water.</p> <p>Calcium has two major problems in Hot Water Chemistry:</p> <ol style="list-style-type: none"> 1. CH has a tendency to precipitate (fall out of suspension in high temperatures, , where pH is above 7.8ppm) 2. High pH will cause calcium to precipitate. The problem with calcium falling out of suspension is that it collects on the heater and pump, and shortens their life. High pH also reduces the life of the Spa Boy Output Electrode. <p>Any natural corrosiveness in the water can be combated by maintaining a slightly higher Total Alkalinity Level.</p>

1.11 Definitions of Terms (continued)

TERM	DEFINITION
<p>Alkalinity Total Alkalinity (TA)</p>	<p>A measure of how stable the pH is (a measure of the total levels of carbonates, bicarbonates, hydroxides, and other alkaline substances in the water).</p> <p>TA is referred to as the water's ""pH buffer"". In other words, it's a measure of the ability of the water to resist changes in pH level.</p> <p>If the TA is too low, the pH level will fluctuate widely from high to low. Fluctuations in pH can cause corrosion or scaling of the spa components.</p> <p>Low TA can be corrected by adding Arctic Pure, Perfect Balance to the spa water.</p> <p>If the Total Alkalinity is too high, the water will be more susceptible to scale and high pH. High pH may be difficult to bring down.</p> <p>Note: Salt systems naturally drive pH levels to increase.</p> <p>High TA can be lowered by adding Arctic Pure, Adjust Down to the spa water.</p> <p>Once the TA is Balanced, it normally remains stable, although some sanitizers, and the addition of more water with a high or low alkalinity will raise or lower the TA reading of the water.</p>
<p>Potential Hydrogen (pH)</p>	<p>The pH level is the measure of alkalinity.</p> <p>pH is measured between 0 and 14 denoting various degrees of acidity or alkalinity.</p> <p>Neutral water has a pH of 7.0 Water below 7.0 is acidic and becomes more acidic as it approaches zero.</p> <p>Water above 7.0 is alkaline and alkalinity increases as it approaches 14.</p> <p>When the pH of water is 7.0 or below, chlorine will act primarily as a sanitizer. At this level, it is very effective at killing bacteria.</p> <p>At 7.4, chlorine will act equally as a sanitizer and oxidizer.</p> <p>Above 7.8, chlorine will act principally as an oxidizer.</p> <p>The pH of chlorine is 11.7ppm.</p> <p>Spa water is considered balanced if the pH level is within the target range, between 7.2pH to 7.6pH.</p> <p>Adding chlorine either automatically through a salt system or manually, into spa water with high pH, above 7.6pH, will further increase the pH level and dramatically reduce the effectiveness of the chlorine as a sanitizer. This must be avoided by first reducing the pH level into the target range 7.2pH - 7.6pH.</p> <p>The chart below reflects the loss of sanitizer effectiveness/sanitizer effectiveness based on the spas water pH level:</p>

pH Level	Sanitizer (Chlorine) Loss of Effectiveness based on pH Level	Sanitizer (Chlorine) Effectiveness based on pH Level
6.0 pH	4%	96%
6.5 pH	10%	90%

1.11 Definitions of Terms (continued)

TERM	DEFINITION																		
<p>Potential Hydrogen (pH) (continued)</p>	<table border="1" data-bbox="618 319 1510 610"> <thead> <tr> <th data-bbox="618 319 903 433">pH Level</th> <th data-bbox="903 319 1194 433">Sanitizer (Chlorine) Loss of Effectiveness based on pH Level</th> <th data-bbox="1194 319 1510 433">Sanitizer (Chlorine) Effectiveness based on pH Level</th> </tr> </thead> <tbody> <tr> <td data-bbox="618 433 903 476">7.0 pH</td> <td data-bbox="903 433 1194 476">27%</td> <td data-bbox="1194 433 1510 476">73%</td> </tr> <tr> <td data-bbox="618 476 903 519">7.2 pH</td> <td data-bbox="903 476 1194 519">38%</td> <td data-bbox="1194 476 1510 519">62%</td> </tr> <tr> <td data-bbox="618 519 903 562">7.5 pH</td> <td data-bbox="903 519 1194 562">50%</td> <td data-bbox="1194 519 1510 562">50%</td> </tr> <tr> <td data-bbox="618 562 903 605">8.0 pH</td> <td data-bbox="903 562 1194 605">78%</td> <td data-bbox="1194 562 1510 605">21%</td> </tr> <tr> <td data-bbox="618 605 903 610">8.5 pH</td> <td data-bbox="903 605 1194 610">90%</td> <td data-bbox="1194 605 1510 610">10%</td> </tr> </tbody> </table> <p>Maintaining a Balanced pH level between 7.2pH and 7.6pH is extremely important for:</p> <ul style="list-style-type: none"> • Optimizing the effectiveness of the sanitizer. • Maintaining water that is comfortable for the user. • Preventing equipment deterioration. • Note: Salt systems naturally drive pH levels to increase, strive to achieve a balanced pH level. <p>If the spa water’s pH level is too low, the following may result:</p> <ul style="list-style-type: none"> • The sanitizer will dissipate rapidly. • The water may become irritation to spa users. • The spa’s equipment may corrode reducing life expectancy. <p>Low pH can be raised by adding Arctic Pure, Adjust Up to the spa water.</p> <p>If the pH level is too high, the following may result:</p> <ul style="list-style-type: none"> • The sanitizer is less effective. • Scale will form on the spa shell surface and the equipment. • High pH will cause calcium to precipitate (fall out of suspension). • The water may become cloudy. <p>High pH can be lowered by adding Arctic Pure, Salt Water Balance to the spa water.</p> <p>It is important to check the pH on a regular basis. The pH will be affected by the bather load, the addition of new water, the addition of various chemicals, and the type of sanitizer used.</p>	pH Level	Sanitizer (Chlorine) Loss of Effectiveness based on pH Level	Sanitizer (Chlorine) Effectiveness based on pH Level	7.0 pH	27%	73%	7.2 pH	38%	62%	7.5 pH	50%	50%	8.0 pH	78%	21%	8.5 pH	90%	10%
pH Level	Sanitizer (Chlorine) Loss of Effectiveness based on pH Level	Sanitizer (Chlorine) Effectiveness based on pH Level																	
7.0 pH	27%	73%																	
7.2 pH	38%	62%																	
7.5 pH	50%	50%																	
8.0 pH	78%	21%																	
8.5 pH	90%	10%																	
<p>ORP</p>	<p>Oxidation–Reduction Potential.</p> <p>This is simply a measurement of the water’s ability to cleanse itself. ORP is measured in millivolts (mV). Also refer FCL</p>																		
<p>Free Chlorine (FCL)</p>	<p>FCL is the active form of chlorine that actually kills bacteria and algae (It is a Sanitizer). Sanitizer is extremely important for killing algae, bacteria and viruses, and preventing unwanted organisms for growing in the spa. At the same time, you don’t want too high a sanitizer level, or it can irritate your skin, lungs and eyes.</p> <p>Always maintain the sanitizer level in your spa within the recommended range.</p> <p>Also refer ORP</p>																		
<p>Chlorine Residual</p>	<p>The actual level of chlorine in the water after the chlorine demand has been satisfied.</p>																		

1.11 Definitions of Terms (continued)

TERM	DEFINITION
Sanitizer	<p>Chemical used to kill bacteria.</p> <p>Generic names: Chlorine, Bromine and Biguanide.</p> <p>Arctic Pure, Boost</p> <p>Adding Arctic Pure BOOST should be avoided unless the ORP level is very low.</p> <p>Also Refer Section 1.15 Caring for your Spa Boy System, Question 3 If the Spa Boy System is not working, what should I do if I need to add Arctic Pure BOOST or other sanitizer to the spas water?</p> <p>Note; resetting the spas breaker could speed up sensor recovery.</p>
Refresh	<p>Oxidiser that is pH Neutral</p> <p>An oxidizer that “burns off” the organic wastes which cause cloudiness and algae. It is a generic term for a chemical used to oxidize organic wastes.</p> <p>If your spa is equiped with an Arctic Spas OZONE System such as Peak 1 or Peak 2 in most cases there should be a reduced need to add Arctic Pure, Refresh to your spas water. This is dependent on bather load and OZONE run time. But weekly maintenance is required.</p>
Parts Per Million (ppm)	<p>ppm: parts per million, a standard measure of chemical or mineral concentration.</p>
Organic waste	<p>Debris such as microorganisms, perspiration, urine, etc. which needs to be burned up or “oxidized” regularly to prevent haze, algae, chloramines, etc.</p>
Shock	<p>An oxidizer that “burns off” the organic wastes which cause cloudiness and algae. It is a generic term for a chemical used to oxidize organic wastes. Arctic Pure, Boost.</p> <p>Warning Adding a Chlorine agent such as Boost to the spas water should be avioded as this will affect the Spa Boy Sensor Probe which will cause inaccurate ORP and pH readings to be sent to My Arctic Spa and registered with My Arctic Spa. If chlorine is added to the spas water it will take at least three days for the Spa Boy Sensor Probe to clense itself and start sending accurate readings to My Arctic Spa.</p> <p>Also Refer Section 1.15 Caring for your Spa Boy System, Question 3 If the Spa Boy System is not working, what should I do if I need to add Arctic Pure BOOST or other sanitizer to the spas water?</p> <p>Note; resetting the spas breaker could speed up sensor recovery.</p>
Salt Water Balance	<p>Arctic pure product specially formulated by Arctic Spas to lower pH without causing any damage to the Spa Boy Output Electrode.</p>
Drop Test Kit	<p>Test kit for testing spa water sample using additives instead of test stips. This type of test method is more effective at measuring the 0.5ppm residual amount of chlorine generated through Spa Boy. 0.5ppm Chlorine reading = approximately 550mV</p>



1.12 Water Chemistry Abbreviations/Acronyms & Ranges

ABBREVIATION/ACRONYMS	DEFINITION	CORRECT CHEMICAL LEVELS
CH	Calcium Hardness	50 - 150 ppm
TA	Total Alkalinity	80-100 ppm
pH	Potential Hydrogen	7.2 – 7.6 ppm
ORP	Oxidation–Reduction Potential	<p>545 – 550 mV Spa Boy Optimum Range.</p> <p>(Optimum Range is the default factory setting, the user may adjust higher if preferred by contacting their dealer to have it adjusted.)</p> <p>Depending on the water chemistry which will be effected by bather load and spa usage, at times the ORP value will overshoot or undershoot the Optimum Range.</p> <p><i>Note: Using a Drop Test Kit, a 0.5ppm Chlorine reading = approximately 550mV</i></p>

1.13 Spa Boy Warranty

Refer to your Arctic Spas Owners Manual for the Spa Boy warranty details. (Pg 29)

1.14 Spa Boy Start - Up Guide

1.14.1 Spa Boy Start-Up Overview Flowchart

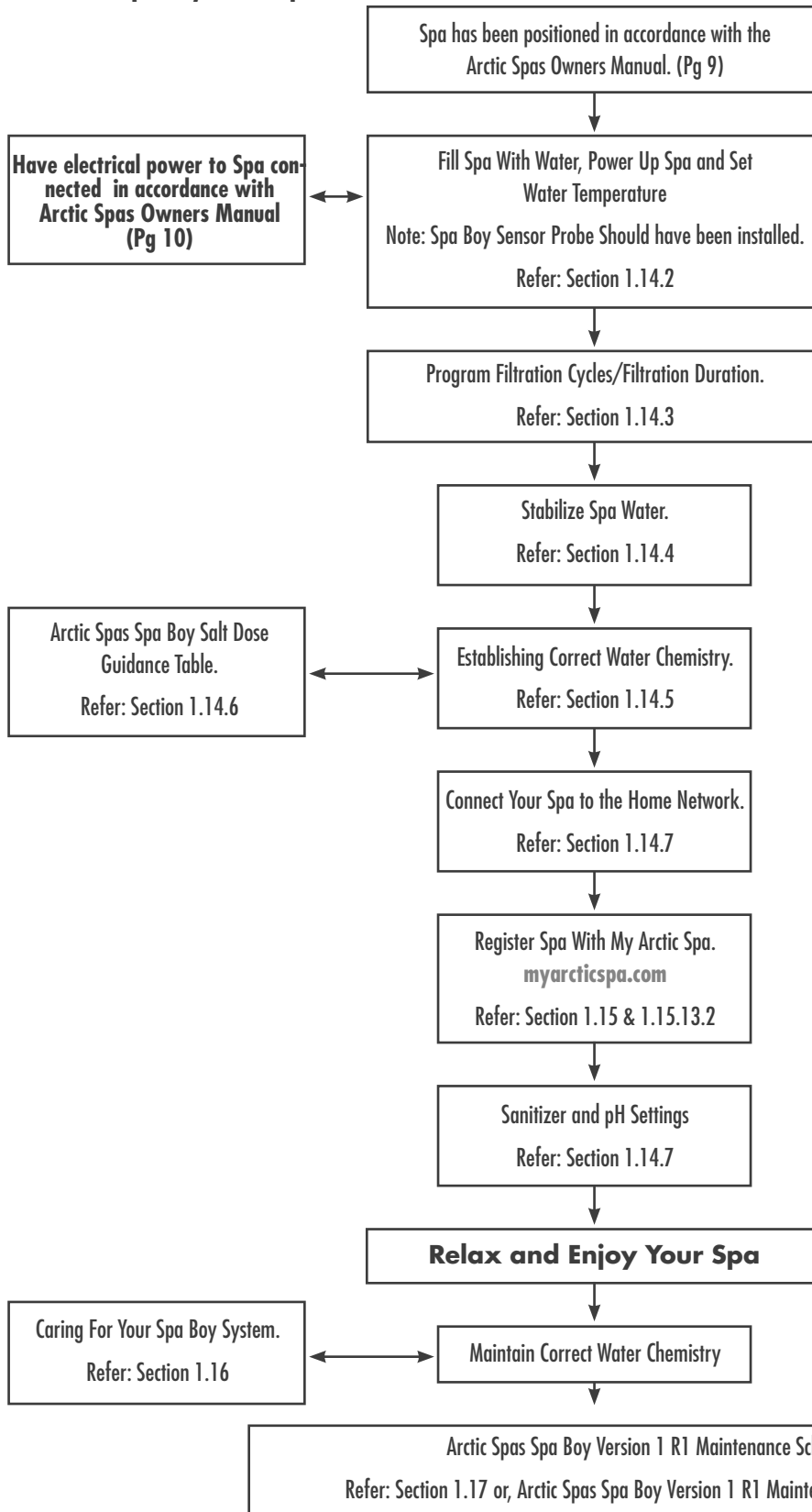

NOTE:

This flowchart provides an overview of the Spa Boy start-up process. The detailed support procedures are contained in this document. All checks and test should be carried out in accordance with the Arctic Spas Spa Boy Owners Manual.



1.14.2 Fill Spa With Water Power Up Spa and Set Water Temperature

The following steps provide guidance to help establish correct chemically balanced water. To help ensure chemicals dissolve appropriately it is good practice to first mix/dissolve the chemical in an uncontaminated container of hot water before carefully adding to the spa water.

Note: The following steps take into account that the Spa Technician has filled your spa with water to above the Spa Boy Sensor Housing, removed the Spa Boy Sensor Plug, installed the Spa Boy Sensor Housing Grate and installed the Spa Boy Sensor.

Warning: Do not proceed until the Spa Technician has filled your spa with water to above the Spa Boy Sensor Housing, removed the Spa Boy Housing Plug, installed the Spa Boy Sensor Housing Grate and installed the Spa Boy Sensor. or you have obtained further direction from your Dealer.

Steps to Fill Spa With Water Power Up Spa and Set Water Temperature



STEP 1. FILL SPA

Fill your spa through the filter intake as shown to the appropriate level (just under the head rests). If you have sediment or high mineral content a "carbon filled pre-filter", as pictured, can help. (This is optional and will prolong the fill time).

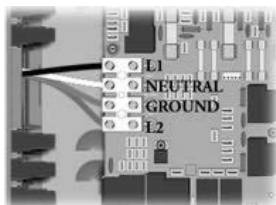

STEP 2. CONNECT/TURN ON ELECTRICAL POWER TO THE SPA

Once the spa is filled to the proper level, connect power to the spa in accordance with the Arctic Spas Owners Manual (Pg 10), and turn the power on to the spa on.





STEP 3. SET WATER TEMPERATURE

Set the water temperature control on the Topside Controller to the desired temperature (between 100°F and 104°F or 38°C and 40°C).

1.14.3 Program Filtration Cycles/Filtration Duration

The factory default filtration settings will automatically perform 4 x two-hour filtration cycles per day, 6 hours apart. Depending of bather load and spa usage it is suggested filtration settings can be changed to automatically perform 4 one- hour filtration cycles per day, 6 hours apart.

The system factory filtration settings can be adjusted by the consumer through:

- OnSpa power management using your device such as smart phone or tablet that has been connected to your spa through WiFi. Refer OnSpa user Guide. (Pg.33)
- The topside controller low level programming. Refer Arctic Spas Quick Reference Card or Arctic Spas Owners Manual. (Pg.43)

1.14.4 Stabilize Spa Water

Before you attempt to balance the water, the water temperature must first reach a minimum temperature of 85°F, (29°C).

Note: Do not be tempted to use your spa at this time.

Step to Stabilize Spa Water



Step 1. Stabilize Spa Water

Once the spa has been filled with water, powered up and filtration requirements set, place the insulated cover on the spa and allow the water temperature to stabilize (**approximately 16 hours**). Make sure you secure the cover in place using the cover locks. Periodically check the spa water temperature.

When the water temperature climbs above 85°F, (29°C) proceed to the next step.

Note: As heat impacts both Calcium and Total Alkalinity a little, it is highly recommended to heat the water above 29°C (85°F) before advancing to Establishing Correct Water Chemistry.

1.14.5 Establishing Correct Water Chemistry

The following steps provide guidance to help establish correct chemically balanced water.

To help ensure chemicals dissolve appropriately it is good practice to first mix/dissolve the chemical in an uncontaminated container of hot water before adding to the spa water.

Steps to Establish Chemically Balanced Water With Spa Boy



Step 1. Test and Adjust Total Alkalinity (Use drop Test Kit)

Test Total Alkalinity. It should be 80 – 100 ppm (100 max). If high, lower Total Alkalinity with Arctic Pure, Salt Water Balance. Do not raise Total Alkalinity!

WARNING: Skipping this step on Start-up can cause scaling problems and cloudy water that may not be covered under warranty.

NOTE: Use all products according to directions on the bottle.



Step 2. Test and Adjust pH (Use drop Test Kit)

Test pH. Levels should be between 7.2 – 7.6.

If pH is high, (over 7.6) add Arctic Pure, Salt Water Balance.

NOTE: Salt systems naturally drive pH levels to increase, strive to achieve a Balanced pH level.

NOTE: High pH will cause calcium to precipitate (fall out of suspension). The problem with calcium falling out of suspension is that it collects on the heater and pump, and shortens their life.



Step 3. Mix Salt Crystals

Dissolve 1/3 of the required recommended salt dosage in a 5 Gallon (20 litre) pail of hot water. Refer Arctic Spas – Spa Boy Salt Dosage Chart contained in this guide.

WARNING: Salt causes pH to rise, to help ensure pH can be managed within the target range, it is most important not to add the entire salt dose in one step. If all the salt is added in one dose it may increase the pH level to an unmanageable level that requires the spas water to be drained.



Step 4. Add Salt to Spa Water & Re-Test TA / pH

(a) Slowly pour the dissolved salt from the pail into the spa water.

(b) Run pumps for 5 minutes to help mix salt blend through.

(c) Wait 1 hour.

(d) Then re-test and adjust pH level accordingly.

Refer: Steps 2 for correct pH levels

Steps to Establish Chemically Balanced Water With Spa Boy

Step 5. Repeat Steps 3 & 4

Repeat steps 3 and 4, ensuring all sub steps are carried out accordingly.

Step 6. Repeat Steps 3 & 4

Repeat steps 3 and 4, ensuring all sub steps are carried out accordingly.

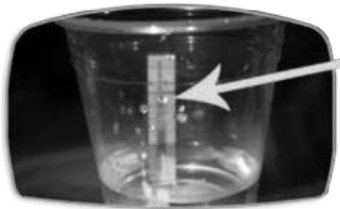

Step 7. Test Sodium Chloride Level (Aquacheck Salt Test Strips are suggested)

Also refer Sub Steps to Help Ensure Sodium Chloride Test Strips are Used Correctly.

You will now need to test sodium chloride levels. This can be carried out using a salt tests strip.

If sodium chloride levels are low, dissolve 1/2 lb (225 Grams) of salt (using cup provided) into hot water. Pour the dissolved salt into the spa water. Test sodium chloride level.

Repeat until required sodium chloride level is reached:

Spa Boy Version	Minimum	Maximum
Version 1 R1	2000ppm	2500ppm

Note: For start up it is recommended to strive for the minimum salt dosage. Once a Sodium Chloride reading has been taken and the minimum salt dosage achieved, it can be increased slightly to accommodate spa usage and bather load.

Note: The Arctic Spa Boy Salt Chart in this guide provides the estimated impact of adding 1/2 lb (225Grams) of salt to your spa.

Sub Steps to Help Ensure Sodium Chloride Test Strips are Used Correctly



Step 1. Take Water Sample

Take a sample of water from the spa in a small cup (about 25mm / 1" full).

NOTE: Always take water samples 25-30cm (12"-18") below the water surface.

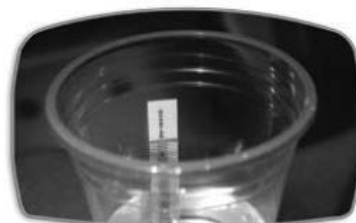

Step 2. Place Test Strip in Water Sample

Place the lower end of the strip into the water.

IMPORTANT Keep top half of strip **COMPLETELY** dry to get an accurate reading.

Sub Steps to Help Ensure Sodium Chloride Test Strips are Used Correctly (*continued*)



Step 3. Test Duration Period

Leave strip in water for 3 – 5 minutes until yellow band at top of strip turns dark.

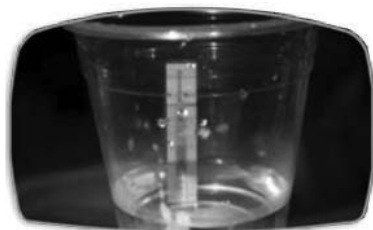

Step 4. Obtain Readings

Obtain your reading: where top of white peak falls on the number scale.

Read top of peak to the nearest 0.2 division.



Step 5. Correspond Test Result Reading

Correspond the test result reading number with the numbers on the bottle.

1.14.6 Arctic Spas Spa Boy Salt Dose Guidance Table

The following table identifies the dosage of Arctic Pure Sea Salt Blend that is required for each Arctic Spa model and estimated impact of adding 225g of salt. Use this table for Spa Boy Version 1 R1.

Operating at the desired salt concentration will reduce potential corrosion and increase the life of the Spa Boy Output Electrode.

Arctic Spas - Spa Boy Version 1 R1 Salt Dosage Chart

Spa Model	Required Salt Dosage to Achieve 2200ppm (Salinity Range for Spa Boy Version 1 R1 must be between 2000 ppm - 25000 ppm)				Estimated Impact of Adding Extra Salt	
	Litres	US Gal	Kg	Lb	225 Grams	1/2 lb
Fox	884	234	2.0	4.4	295 ppm	295 ppm
Glacier	1144	302	2.6	5.6	216ppm	216ppm
Glacier XI	1300	343	3.0	6.6	190ppm	190ppm
Cub	1185	313	2.6	5.6	210ppm	210ppm
Klondiker	1431	378	3.2	7.1	173ppm	173ppm
Frontier	1330	351	3.0	6.6	188ppm	188ppm
Summit	1405	371	3.2	6.9	175ppm	175ppm
Summit XL	1988	525	4.5	10	122ppm	122ppm
Yukon	1360	359	3.1	6.7	180ppm	180ppm
Kodiak	1592	420	3.6	7.8	157ppm	157ppm
Norwegian	1565	413	3.5	7.7	157ppm	157ppm
Tundra	1700	449	3.8	8.4	147ppm	147ppm
Swim Spa (AWP)	5100	1347	11.4	25.1	49ppm	49ppm

Note: The above table provides a guideline to achieve a salinity level of 2200 ppm. Due to differing levels of compounds and chemicals in water in different suburbs and countries, please ensure you confirm salinity level is in the desired salinity range using Aquacheck Salt Test Strips

1.14.7 Sanitizer and pH Readings

The following provides guidance on the establishment and maintenance of sanitizer and pH readings.

Sanitizer Readings

You should have ORP sanitizer (Chlorine) readings within 24 hours.

24 hours post adding the salt to the spas water, My Arctic Spa will be able to provide accurate readings regarding the ORP sanitizer (chlorine) reading, and pH reading.

Important: Always check the pH and ORP (sanitizer) levels before each spa use.

If the pH reading is out of range (to high), adjust accordingly with Arctic Pure, Salt Water Balance

* Expect the pH too increase slowly over each week and when the pH gets too high use Arctic Pure, Salt Water Balance to correct it.

High pH will cause premature failure of the Spa Boy Output Electrode, cloudy water, and decreased effectiveness of the sanitizer.



1.15 Caring for your Spa Boy System

Spa Boy Maintenance

Question 1 How do I Replace the Spa Boy Output Electrode?

The Spa Boy Output Electrode should be replaced every 12 months. Doing this ensures Sanitizer will be produced and sanitizer remains in the required range. The App also shows a " BATTERY" displaying the amount of life left in the Spa Boy Salt Cell. Accuracy of the display is dependent on the salt dosage being within the required range 2000ppm – 2500ppm.

The Spa Boy Output Electrode can be replaced without draining the spas water providing these steps are followed.

Steps:

- Turn the breaker off to isolate power to your Spa.
- Unscrew the Spa Boy Niche out of its housing.
- Raise the Niche completely out of the spas water and dry off any water on the Niche and Electrode.
- To help prevent galvanic corrosion, it is critical to ensure that spa water does not come into contact with the Spa Boy Electrode Electrical Pin or female matting connection located on the Spa Boy Niche when disconnecting the Niche from the Spa Boy Electrode.

* **Keep them high and keep them dry, when replacing the Spa Boy Output Electrode!**

- With a small Phillips screwdriver unscrew the set screw that secures the Spa Boy Output Electrode to the Niche.
- Remove the Spa Boy Output Electrode from the Niche by Unscrewing the Electrode anticlockwise and ensure the small O-ring has not dislodged from the Electrode and remained behind inside the Niche.
- Ensure the new Electrode has the small O-ring correctly seated into the groove that is positioned around the electrical pin.
- Inspect the male electrical connection plug in the Niche to ensure it is not corroded. If corroded the dealer will need to be contacted as the Spa Boy Niche Assembly will require replacement.
- Apply Dielectric Grease to the electrical pin on the new Spa Boy Electrode.
- Insert the Spa Boy Electrode back into the Niche and turning clockwise screw the Electrode into the Niche until tight and the locating hole has aligned (approximately 4 revolutions).
- Insert the set screw into the Electrode and using a Phillips screwdriver tighten the set screw.
- Tuck the wiring loom back into the Housing.
- Screw the Niche back into its Housing ensuring the Electrode points upwards when tight. This ensures maximum output from the Electrode.
- Turn the breaker back on to repower your spa.

Question 2 How do I Care for the Spa Boy Sensor?

The Spa Boy Sensor must never be permitted to freeze and must always remain in contact with water. If the Sensor freezes or is not left in contact with water at all times the sensor will fail and will require replacement!

1.15 Caring for your Spa Boy System Spa Boy Maintenance

Question 3 How do I Care for the Spa Boy Sensor when Draining the Spas Water?

As the Spa Boy Sensor must always remain in contact with water, when the spas water is being drained the Spa Boy Sensor Housing must be sealed before the water is drained.

The Spa Boy Sensor Housing is usually located in the foot well or other area of the spa that is not in the way of bathers or impacted by water turbulence from jets. The Spa Boy Housing has a Grate screwed into the front of the Housing.

Steps for caring for your Spa Boy Sensor when draining the spas water:

- Find your 2" (50mm) Spa Boy Housing Plug that was installed in the Spa Boy Sensor Housing when your spa was first delivered.
- Check to ensure the Spa Boy Housing Plug has an O-ring in place, which is used to generate a seal between the plug and housing when the plug is screwed into the housing.
- Turn the breaker off to isolate power to your Spa.
- Turning counter clockwise, unscrew the Grate located on the front of the Spa Boy Sensor Housing.
- Screw the Spa Boy Housing Plug provided with your spa into the front of the Spa Boy Sensor Housing. This will seal the water that is in the Housing and prevent the water in the Housing from draining when you drain your spas water.

Warning: The Spa Boy Sensor must never be permitted to freeze and must always remain in contact with water. If the Sensor freezes or is not left in contact with water at all times the sensor will fail and will require replacement! Such failures are not covered by warranty.

- You can now drain your spas water.
- Clean the Spa shell with a mixture of water and white vinegar. Rinse the shell down with fresh water and then polish the shell with Arctic Pure, Reflection.
- When refilling your spa with water, leave the Spa Boy Sensor Plug secured in place until the water line is higher than the Spa Boy Housing.
- The Spa Boy Housing Plug can now be unscrewed from the Housing and the Housing Grate can be screwed back into the Housing.
- Once the water level has been reached the bottom of the pillow line you can turn the breaker back on to repower your spa.

1.15 Caring for your Spa Boy System Spa Boy Maintenance

Question 4 Does adding salt to the spas water impact pH?

Yes adding salt to the spas water will increase the pH level.

The chlorine that is produced by a salt chlorinator plays a role in the water chemistry of a salt spa. Salt is sodium chloride. When an electric charge is passed through salt water, the sodium chloride is turned into sodium hypochlorite. This is the same kind of chlorine that is sold by the gallon as liquid chlorine. The most important feature of sodium hypochlorite is a high pH. When the salt chlorinator produces chlorine, it raises the pH of the spas water. Strive to achieve a Low pH level 7.2. pH must not exceed 7.6.

Question 5 What do I do if my ORP Reading is below the Optimum Range?

If Spa Boy reflects that the ORP is below the Optimum Range of 545 – 550 mV you must first consider that water chemistry may have been affected by recent bather load and spa usage, at times the ORP value will overshoot or undershoot the Optimum Range.

If the Spa Boy Dashboard on My Arctic Spa reflects that the ORP is below 545 mV do the following:

Check Spa Boy Dashboard through My Arctic Spa to see if the Dashboard reflects **sanitizing YES**, if yes Spa Boy is currently producing sanitizer. Re-check ORP in a few hours to confirm ORP is increasing.

If Dashboard reflects **Sanitizing NO**:

Trip the spas breaker to isolate the power to the spa and then turn the breaker back on to repower the spa.

Check Spa Boy Dashboard through My Arctic Spa to see if the Dashboard reflects **sanitizing YES**, if yes Spa Boy is currently producing sanitizer. Re-check ORP in a few hours to confirm ORP is increasing.

If Dashboard reflects **Sanitizing NO**:



First try pressing the Spa Boy BOOST button on the Arctic Spas App or myarcticspa.com dashboard under "Settings/Spa Boy Status" to manually activate the Spa Boy system for 30 minutes. If the dashboard still reflects Sanitizing No,

Contact your Arctic Spas Dealer who will request a Master Technician to log onto your spa to determine the possible cause, such as depleted Spa Boy Output Electrode, Spa Boy Sensor issue or corroded Spa Boy Output Electrode electrical connections.

1.15 Caring for your Spa Boy System Spa Boy Maintenance

Question 6 If the Spa Boy System is not working, can I add Arctic Pure BOOST or other sanitizer to the spas water?

Yes you can add Arctic Pure BOOST if needed.

Arctic Pure BOOST or other chlorine sanitizer shouldn't need to be added regularly to keep up with regular bather load.

Adding Arctic Pure BOOST or other chlorine sanitizers will raise sanitizer levels above the Spa Boy Systems maintained chlorine/ORP optimum range (545mV-550mV) causing the Spa Boy System to shut down until the chlorine/ORP reading is below the optimum range, 545mV/ORP.

- Adding BOOST can temporarily "poison" the SpaBoy sensor for 24-48 hours.
Do not trust the ORP reading until water has stabilized.

Question 7 Is it permitted to add Arctic Pure Refresh directly to the spas water?

Yes it is required to add Arctic Pure Refresh directly to the spas water.

At a minimum 1 capfull per week should be added for a spa and 2 caps full for an AWP.

Reduced amounts of Arctic Pure, Refresh can be used in spas equipped with an Arctic Spas OZONE System such as Peak 1 or Peak 2.

Arctic Pure Refresh has little effect on the Spa Boy Sensor Probe

1.15 Caring for your Spa Boy System

Spa Boy Maintenance

Question 8 How do I help prevent impedance increase at the Spa Boy Electrode?

Maintain the pH level within the target range 7.2 pH – 7.6 pH.

As salt systems naturally drive pH levels upwards, it is most critical to the performance/life of the salt system to maintain the pH within the target range.

High pH reduces the effectiveness of chlorine.

- pH level of 7 makes chlorine 70% effective (30% loss of effectiveness).
- pH level of 8 makes chlorine 21% effective (79% loss of effectiveness).

Therefore, high pH causes your Spa Boy system to produce more chlorine unnecessarily thus increasing pH even higher and reducing the effectiveness of chlorine even further.

Strive to achieve a Low pH level 7.2. pH must not exceed 7.6.

Question 9 Why is my water bright yellow, or bright green, or a rusty colour suddenly?

This can happen if the pH gets too high.

Maintain the pH level within the target range 7.2 pH – 7.6 pH.

Lower the pH using 'Salt Water Balance'. If the colour of the water does not normalize you may need to replace the water.

If pH readings are 8.2ppm or above, a pH error will be displayed on the Top Side Controller every five seconds until the pH is corrected.

*** Keep an eye on the pH and adjust it weekly to avoid this problem in the future.**

1.15 Caring for your Spa Boy System Spa Boy Maintenance

Question 10 What happens if my water becomes cloudy?

1. Check your pH level to ensure it is in the target range. If high Lower the pH using 'Adjust Down'
2. Check/Test the water with a drop test kit for chlorine content. If the level is below 0.5ppm or there is no reading the Spa Boy Output Electrode may be exhausted and require replacement. Check Cell Life Monitor on Arctic Spas App or myarcticspa.com dashboard under "Settings/Spa Boy Status", remaining Cell life is displayed as a green coloured battery . The green band on the battery will reduce in height as the Cell becomes depleted.
3. Check that the Salinity reading is within the desired range, 2000ppm and 2500ppm. If salinity reading is below the range it can cause the Cell Life Monitor to display as Red, which implies the Spa Boy Salt Cell is exhausted when it may not be.
4. Check your filters as they may require replacement.



Question 11 Should I use Best Defence or another scale remover?

It is recommended that calcium be removed from the water in advance, during the fill process with the aid of a pre-filter and when establishing initial correct water chemistry, rather than adding a scale remover after the fact.

Calcium readings below 150ppm should be maintained.

Question 12 What is the impact of phosphates on the Spa Boy system?

High levels of phosphates (above 250 ppb) may reduce the effectiveness of sanitizer output.

1.15 Caring for your Spa Boy System Spa Boy Maintenance

Question 13 Can I use softened water with my Spa Boy system?

Yes, you probably have a water softener because your water is quite hard. Your water-softener removes calcium from your water and helps you achieve water with calcium content near the target range, between 50 - 150 ppm.

Question 14 Prior to draining spa water for refill purposes, should a system flush be carried out?

Yes you can, Arctic Pure 'Fresh Start'. Use in accordance with the instructions on the container. Flushing the system components and hoses is helpful when you get biofilm and calcium build-up.

It is good practice to do this at least once a year.

Question 15 If I am going to have a very heavy bather load, is there a way to manually active the Spa Boy System to generate additional sanitizer (Increase ORP Level)?

Yes you can.



Pressing the Boost Button through the App or dashboard in myarcticpas.com will manually activate the Spa Boy System for 30 minutes. Boost button can be activated in such cases when you know you are going to have a heavy bather load.

CAUTION: Only press the Boost Button once.

When the Boost Button is pressed:

- The Lightening Bolt on the Boost Button will illuminate and then,
- The Spa Boy Generator will turn On and Off TWICE along with the Lightening Bolt, and then,
- The Boost function commences its 30-minute cycle. During this cycle the Lightening Bolt remains illuminated.

Pressing the Boost button more than once will cause the Boost function not to activate.

1.16 Arctic Spas Spa Boy Version 1 R1 Maintenance Schedule

The following table outlines the typical water maintenance program required for an Arctic Spa fitted with Spa Boy Version 1 R1.

To help ensure chemicals dissolve appropriately it is good practice to first mix/dissolve the chemical in an uncontaminated container of hot water before carefully adding to the spa water. There are two methods to check the target range:

- My Arctic Spa Application, if your spa has Wi-Fi and access to the internet through your home network or portable device such as iPad or smart phone, you can log onto My Arctic Spa and open the Settings Page and go to Spa Boy Status page to review the readings (To access My Arctic Spa you must first register your details on the My Arctic Spa web site: www.myarcticspa.com).
- Drop Test Kit or by taking a water sample to your local spa dealer

pH	Weekly	Check the Potential Hydrogen (pH) to ensure it is in the target range. Always first check to ensure the pH is within the target range. If the pH is out of the target range pH must be adjusted before making any adjustments to chlorine levels	7.2 – 7.6 pH	
ORP	Weekly (& before each use)	Check the Free Chlorine Level to ensure it is in the target range.	545–550 mV /ORP Using a Drop Test Kit, 0.5ppm Chlorine reading = approximately 550mV	
Sodium Chloride	Monthly	Check the Sodium Chloride Level to ensure it is in the target range.	Version 1 R1 2000 – 25000 ppm	
Shock	Weekly	Shock the spas water with Arctic Pure, Refresh	N/A	
Filter	3 Monthly	Change the filter(s)	N/A	
Water	6 Monthly	Change the water	N/A	

Maintenance Action to Adjust/Correct	
	<p>As Salt systems naturally drive pH levels upwards, it is most critical to the performance/life of the salt system to maintain the pH within the target range.</p> <p>High pH reduces the effectiveness of chlorine.</p> <ul style="list-style-type: none"> • pH level of 7.2 makes chlorine 62% effective (38% loss of effectiveness). • pH level of 7.5 makes chlorine 50% effective (50% loss of effectiveness). • pH level of 8 makes chlorine 21% effective (79% loss of effectiveness). <p>Therefore, high pH causes your Spa Boy system to produce more chlorine thus increasing pH even higher and reducing the effectiveness of chlorine even further.</p> <p>Strive to achieve a Low pH level 7.2. pH must not exceed 7.6. If pH is slightly below 7.0ppm do not adjust.</p> <p>Low pH - Can be raised by adding Arctic Pure, Adjust Up to the spa water.</p> <p>High pH - Can be lowered by adding Arctic Pure, Adjust Down to spa water.</p>
	<p>545-550 mV is the Optimum Range factory default setting.</p> <p>The user may adjust higher if preferred by contacting their dealer to have it adjusted. Spa Boy will strive to maintain ORP within the Optimum Range.</p> <p>Depending on the water chemistry which will be affected by bather load and spa usage, at times the ORP value will overshoot or undershoot the Optimum Range.</p>
	<p>Once Sodium Chloride reading is in the target range salt concentration will only change if water is splashed or drained out. Do not add salt unless this test confirms the level is below the chemical acceptable range.</p> <p>High Sodium Chloride - add water above 2500ppm</p> <p>Low Sodium Chloride - add salt below 2000ppm</p>
	<p>At a minimum 1 capful per week should be added for a spa and 2 caps full for an AWP. This amount can be reduced if your spa is equipment with an Arctic Spas OZONE System.</p>
	<p>Change the filter(s) in accordance with Owners Manual instructions. (Pg.19)</p>
	<p>Change the water in accordance with Owners Manual instructions. (Pg.22)</p>

1.17 Troubleshooting Spa Boy Low ORP Reading Detected

The following flowchart can be used to troubleshoot the Spa Boy system when Low ORP reading has been detected.

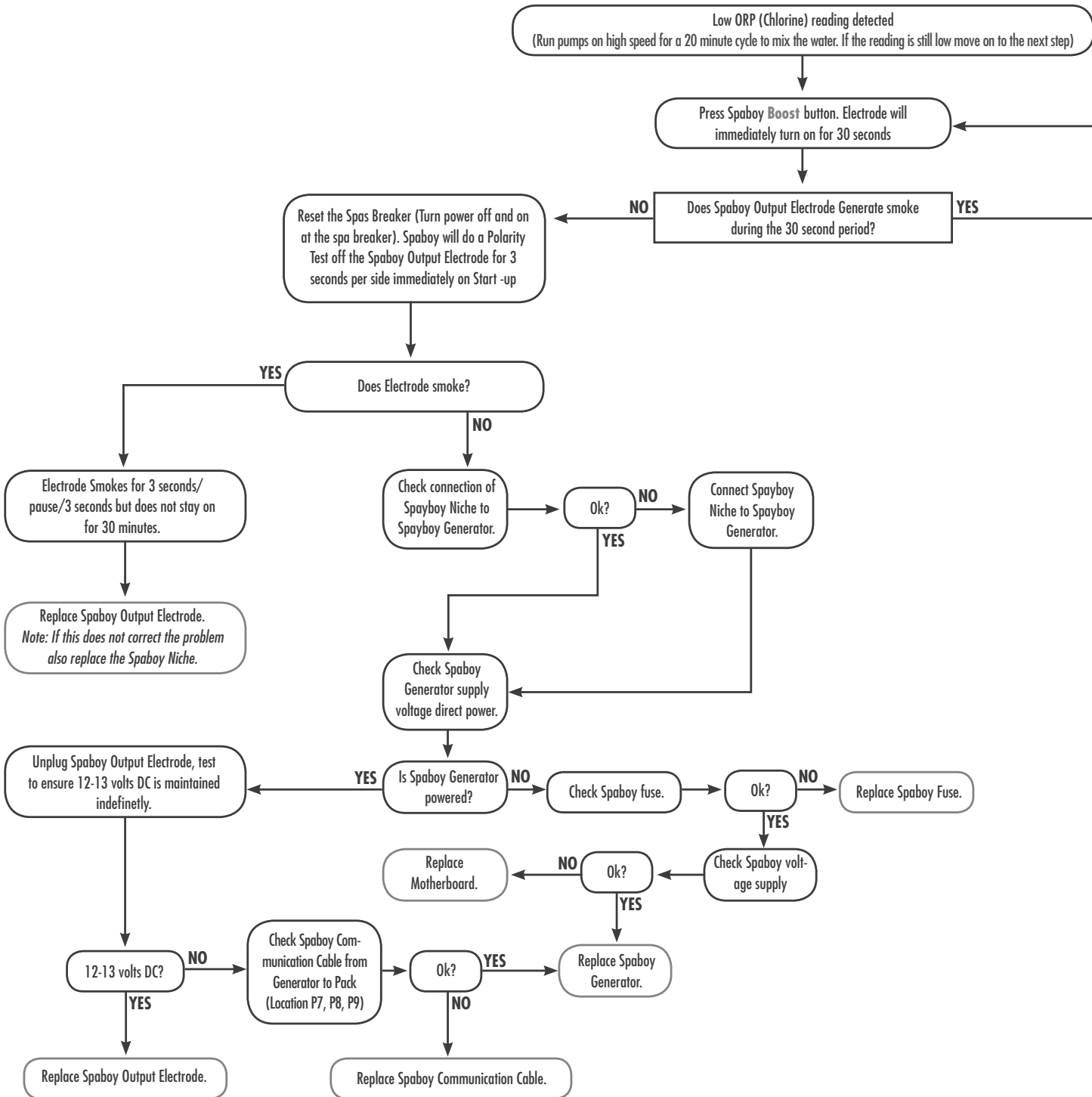

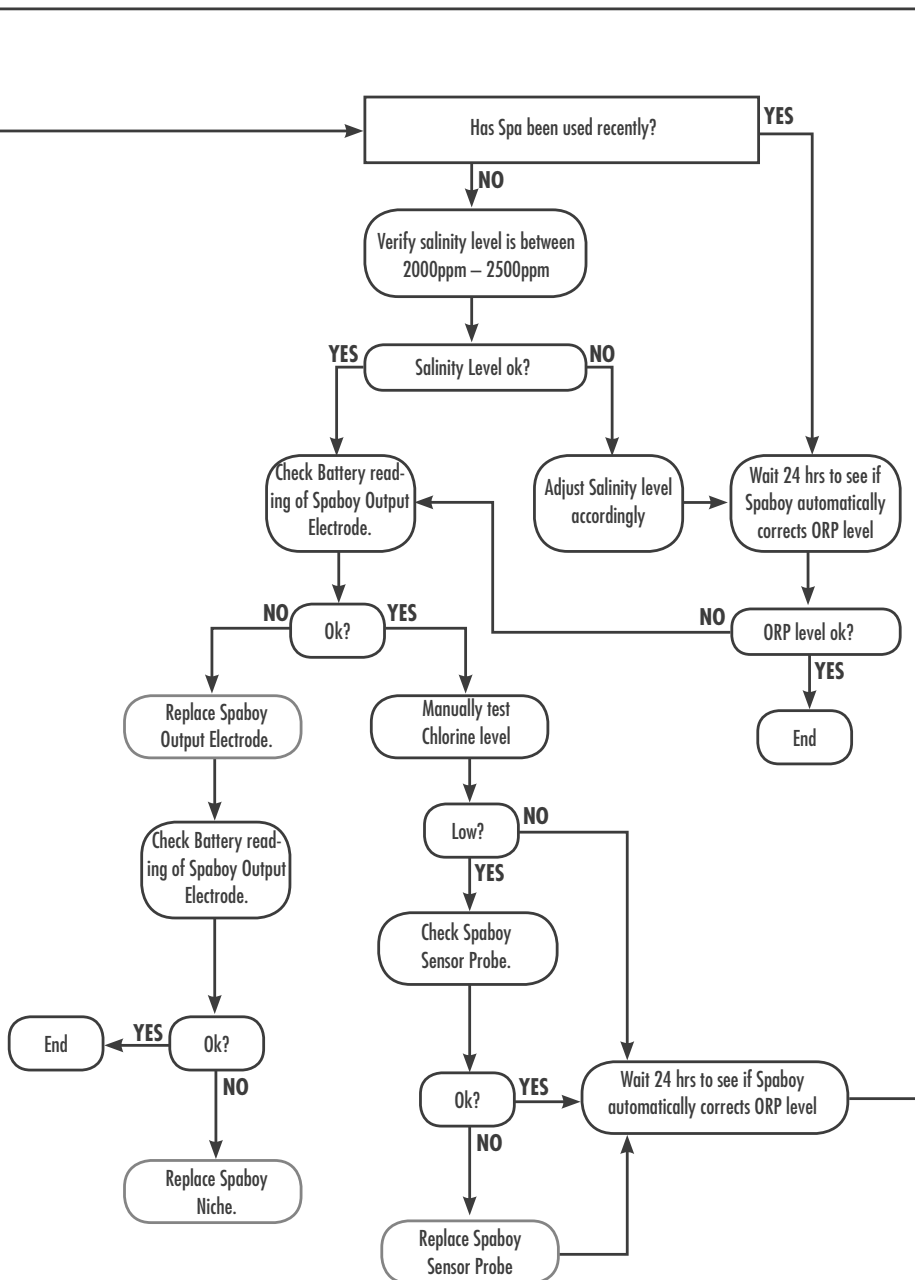

ONZEN OWNERS MANUAL

1.0 Onzen Technical Guide

1.1 Obtaining Technical Data For Your Spa

To ensure you have the current appropriate technical data for your spa it is recommended that you obtain such data from your authorized retailer or from the Arctic Spas Web Site <http://www.arcticspas.com>.

1.2 Revision Summary

This publication has been fully revised to provide the supporting details Onzen Version 8, and spas with the Eco-Pak spa controller.

1.3 What is Onzen?

Onzen is an all-natural, salt-water softening and maintenance system.

1.4 What Does Onzen Do?

- Softens water.
- Clarifies water.
- Adds back up sanitizing (Chlorine) agents, automatically.

1.5 What Are The Benefits of Onzen?

- Makes skin feel soft and smooth.
- Makes water look sparkling clean.
- Reduces contact with harsh chemicals.
- Dramatically reduces time and money needed to maintain spa water.
- Reduces impact to the environment:
 1. Fewer trips to the spa store for supplies.
 2. Less packaging wasted on chemical containers.
 3. Less industrial waste produced making spa chemicals.

1.6 How Does Onzen Work?

- Natural mineral sea salt blend is added to water when spa is filled.
- Sanitizing agents (Chlorine) are produced and mixed with water, automatically.
- Output is easily controlled to suit very low to very high use.

1.7 How to Determine Spa Production Date

The Spa production date can be determined from the Spa Serial Number recorded on the Spa Identification Plate mounted on the cabinet usually under the topside controller.

Example

Spa Serial No. A10H131112

- The two digits following the first letter represent the year that the Spa was built 10 = 2010.
- The letter following the first two digits represent the month that the Spa was built H = August.

1.8 Definitions of Terms

TERM	DEFINITION
Onzen	An all-natural, salt-water softening and maintenance system.
Onzen Output Electrode	<p>Three plate platinum-iridium Titanium electrode - equipped salt cell converts the saltwater solution to sanitizer, and as this solution reverts back to its natural form (salt) after sanitizing. Unless large volumes of water are added to the spa you never have to add more salt. The Three plate electrode plastic outer casing is black in color.</p> <p><i>Note: When the Onzen System has activated the Output Electrode to generate sanitizer, the electrode gives off smoke effect.</i></p>
Onzen Output Electrode Version	Modification status of the electrode fitted to the spa.
Calcium Hardness (CH)	<p>Calcium Hardness is a measure of the total amount of dissolved calcium salts in the water. CH helps determine how scaling or corrosive the water is. It is believed that calcium helps control the corrosive nature of water.</p> <p>Calcium has two major problems in Hot Water Chemistry:</p> <ol style="list-style-type: none"> 1. CH has a tendency to precipitate (fall out of suspension in high temperatures, , where pH is above 7.8ppm) 2. High pH will cause calcium to precipitate. The problem with calcium falling out of suspension is that it collects on the heater and pump, and shortens their life. High pH also reduces the life of the Onzen Output Electrode. <p>Any natural corrosiveness in the water can be combated by maintaining a slightly higher Total Alkalinity Level.</p>
Alkalinity Total Alkalinity (TA)	<p>A measure of how stable the pH is (a measure of the total levels of carbonates, bicarbonates, hydroxides, and other alkaline substances in the water).</p> <p>TA is referred to as the water's ""pH buffer"". In other words, it's a measure of the ability of the water to resist changes in pH level.</p> <p>If the TA is too low, the pH level will fluctuate widely from high to low. Fluctuations in pH can cause corrosion or scaling of the spa components.</p> <p>Low TA can be corrected by adding Arctic Pure, Perfect Balance to the spa water.</p> <p>If the Total Alkalinity is too high, the water will be more susceptible to scale and high pH. High pH may be difficult to bring down.</p> <p>Note: Salt systems naturally drive pH levels to increase.</p> <p>High TA can be lowered by adding Arctic Pure, Adjust Down to the spa water.</p> <p>Once the TA is Balanced, it normally remains stable, although some sanitizers, and the addition of more water with a high or low alkalinity will raise or lower the TA reading of the water.</p>

TERM	DEFINITION																								
<p>Potential Hydrogen (pH)</p>	<p>The pH level is the measure of alkalinity. pH is measured between 0 and 14 denoting various degrees of acidity or alkalinity. Neutral water has a pH of 7.0 Water below 7.0 is acidic and becomes more acidic as it approaches zero. Water above 7.0 is alkaline and alkalinity increases as it approaches 14. When the pH of water is 7.0 or below, chlorine will act primarily as a sanitizer. At this level, it is very effective at killing bacteria. At 7.4, chlorine will act equally as a sanitizer and oxidizer. Above 7.8, chlorine will act principally as an oxidizer. The pH of chlorine is 11.7ppm.</p> <p>Spa water is considered balanced if the pH level is within the target range, between 7.2pH to 7.6pH.</p> <p>Adding chlorine either automatically through a salt system or manually, into spa water with high pH, above 7.6pH, will further increase the pH level and dramatically reduce the effectiveness of the chlorine as a sanitizer. This must be avoided by first reducing the pH level into the target range 7.2pH - 7.6pH.</p> <p>The chart below reflects the loss of sanitizer effectiveness/sanitizer effectiveness based on the spas water pH level:</p> <table border="1" data-bbox="379 825 1273 1177"> <thead> <tr> <th>pH Level</th> <th>Sanitizer (Chlorine) Loss of Effectiveness based on pH Level</th> <th>Sanitizer (Chlorine) Effectiveness based on pH Level</th> </tr> </thead> <tbody> <tr> <td>6.0 pH</td> <td>4%</td> <td>96%</td> </tr> <tr> <td>6.5 pH</td> <td>10%</td> <td>90%</td> </tr> <tr> <td>7.0 pH</td> <td>27%</td> <td>73%</td> </tr> <tr> <td>7.2 pH</td> <td>38%</td> <td>62%</td> </tr> <tr> <td>7.5 pH</td> <td>50%</td> <td>50%</td> </tr> <tr> <td>8.0 pH</td> <td>78%</td> <td>21%</td> </tr> <tr> <td>8.5 pH</td> <td>90%</td> <td>10%</td> </tr> </tbody> </table>	pH Level	Sanitizer (Chlorine) Loss of Effectiveness based on pH Level	Sanitizer (Chlorine) Effectiveness based on pH Level	6.0 pH	4%	96%	6.5 pH	10%	90%	7.0 pH	27%	73%	7.2 pH	38%	62%	7.5 pH	50%	50%	8.0 pH	78%	21%	8.5 pH	90%	10%
pH Level	Sanitizer (Chlorine) Loss of Effectiveness based on pH Level	Sanitizer (Chlorine) Effectiveness based on pH Level																							
6.0 pH	4%	96%																							
6.5 pH	10%	90%																							
7.0 pH	27%	73%																							
7.2 pH	38%	62%																							
7.5 pH	50%	50%																							
8.0 pH	78%	21%																							
8.5 pH	90%	10%																							
	<p>Maintaining a Balanced pH level between 7.2pH and 7.6pH is extremely important for:</p> <ul style="list-style-type: none"> • Optimizing the effectiveness of the sanitizer. • Maintaining water that is comfortable for the user. • Preventing equipment deterioration. • Note: Salt systems naturally drive pH levels to increase, strive to achieve a balanced pH level. <p>If the spa water's pH level is too low, the following may result:</p> <ul style="list-style-type: none"> • The sanitizer will dissipate rapidly. • The water may become irritation to spa users. • The spa's equipment may corrode reducing life expectancy. <p>Low pH can be raised by adding Arctic Pure, Adjust Up to the spa water.</p> <p>If the pH level is too high, the following may result:</p> <ul style="list-style-type: none"> • The sanitizer is less effective. • Scale will form on the spa shell surface and the equipment. • High pH will cause calcium to precipitate (fall out of suspension). • The water may become cloudy. <p>High pH can be lowered by adding Arctic Pure, Salt Water Balance to the spa water.</p> <p>It is important to check the pH on a regular basis. The pH will be affected by the bather load, the addition of new water, the addition of various chemicals, and the type of sanitizer used.</p>																								

TERM	DEFINITION
<p>Chlorine Free Chlorine (FCL)</p>	<p>FCL is the active form of chlorine that actually kills bacteria and algae (It is a Sanitizer). Sanitizer is extremely important for killing algae, bacteria and viruses, and preventing unwanted organisms for growing in the spa. At the same time, you don't want too high a sanitizer level, or it can irritate your skin, lungs and eyes.</p> <p>Always maintain the sanitizer level in your spa within the recommended range.</p> <p>Also refer ORP</p>
<p>Chlorine Residual</p>	<p>The actual level of chlorine in the water after the chlorine demand has been satisfied.</p>
<p>Sanitizer</p>	<p>Chemical used to kill bacteria.</p> <p>Generic names: Chlorine, Bromine and Biguanide.</p> <p>Arctic Pure, Boost</p> <p>Adding Arctic Pure BOOST should be avoided unless the ORP level is very low.</p>
<p>Parts Per Million (ppm)</p>	<p>ppm: parts per million, a standard measure of chemical or mineral concentration.</p>
<p>Organic waste</p>	<p>Debris such as microorganisms, perspiration, urine, etc. which needs to be burned up or "oxidized" regularly to prevent haze, algae, chloramines, etc.</p>
<p>Shock</p>	<p>An oxidizer that "burns off" the organic wastes which cause cloudiness and algae. It is a generic term for a chemical used to oxidize organic wastes. Arctic Pure, Boost.</p>
<p>ORP</p>	<p>Oxidation–Reduction Potential.</p> <p>This is simply a measurement of the water's ability to cleanse itself. ORP is measured in millivolts (mV). Also refer FCL</p>

1.9 Water Chemistry Abbreviations/Acronyms & Levels

ABBREVIATION/ACRONYMS	DEFINITION CORRECT	CHEMICAL LEVELS
CH	Calcium Hardness	50 - 150 ppm
TA	Total Alkalinity	80-100 ppm
pH	Potential Hydrogen	7.2 – 7.6 ppm
FCL	Free Chlorine	1 – 3 ppm
ORP	Oxidation–Reduction Potential	600 - 1000

1.10 Settings Abbreviations Acronyms

ABBREVIATION/ ACRONYMS	DEFINITION
Fd	<p>Filter Cycle Duration</p> <p>Fd 00 = no filtration. Fd 01 = 1 hour/cycle. Fd 02 = 2 hour/cycle. Fd 03 = 3 hour/cycle. Fd 04 = 4 hour/cycle. Fd 05 = 5 hour/cycle. Fd 06 = 6 hour/cycle.</p>
FF	<p>FF</p> <p>Filter Cycle Frequency</p> <p>FF 1 = 1 cycle in 24 hours. FF 2 = 2 cycles in 24 hours. FF 3 = 3 cycles in 24 hours. FF 4 = 4 cycles in 24 hours.</p>
On	<p>Onzen Cycle Duration</p> <p>0-24 Hours per day</p> <p>* Cycles are divided into 4</p> <p>ie: If 8 hours is selected, the system will perform 4 x 2 hour cycles per day.</p>
O3	<p>Ozone Cycle Duration</p> <p>0-24 hours per day</p> <p>* Peak II only, if Peak 1 is installed ozone will run during filtration.</p>

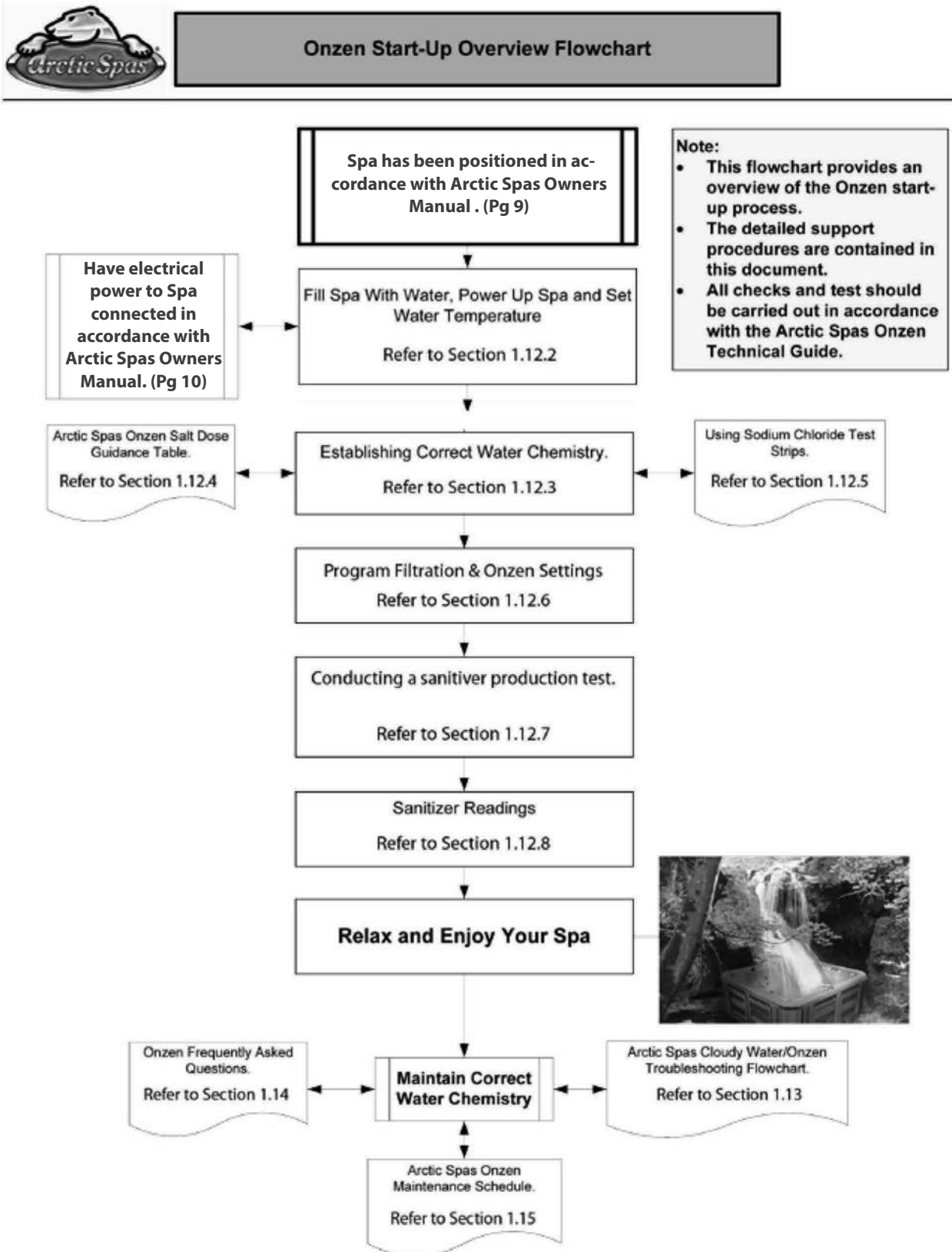

1.11 Onzen Start - Up Guide

1.11.1 Onzen Start - Up Overview Flowchart



1.11.2 Fill Spa With Water, Power Up Spa and Set Water Temperature

The following steps provide guidance to help establish correct chemically balanced water. To help ensure chemicals dissolve appropriately it is good practice to first mix/dissolve the chemical in an uncontaminated container of hot water before carefully adding to the spa water.

Steps to Fill Spa With Water Power Up Spa and Set Water Temperature	
	<p>Step 1. Fill Spa Fill your spa through the filter intake as shown to the appropriate level (just under the head rests). If you have sediment or high mineral content a "carbon filled pre-filter", as pictured, can help. (This is optional and will prolong the fill time).</p>
	<p>Step 2. Connect/Turn on Electrical Power to the spa once the spa is filled to the proper level, and turn the power on to the spa on.</p>
	<p>Step 3. Set Water Temperature Set the water temperature control on the Topside Controller to the desired temperature (between 100oF and 104oF or 38°C and 40°C).</p>

ONZEN OWNERS MANUAL

1.11.3 Establishing Correct Water Chemistry

The following steps provide guidance to help establish correct chemically balanced water.

To help ensure chemicals dissolve appropriately it is good practice to first mix/dissolve the chemical in an uncontaminated container of hot water before carefully adding to the spa water.

Steps to Establish Chemically Balanced Water With Onzen



Step 1. Test and Adjust Calcium / Total Alkalinity

(a) Test Calcium hardness. Level should be between 50-150 ppm. If high, lower with a stain & scale controller such as Arctic Pure, Best Defence, to help hold the Calcium in suspension.

NOTE: Salt systems perform best with Low Calcium levels.

(b) Test Total Alkalinity. It should be 80 – 100 ppm (100 max). If high, lower Total Alkalinity with Arctic Pure, Adjust Down (pH Down) or muriatic acid. Do not raise Total Alkalinity!

WARNING: Skipping these steps on Start-up can cause scaling problems and cloudy water that may not be covered under warranty.

NOTE: Use all products according to directions on the bottle.



Step 2. Test and Adjust pH

Test pH. Levels should be between 7.2 – 7.6.

If pH is high, (over 7.6) add Arctic Pure, Adjust Down. If pH is low, (under 7.2) add Arctic Pure, Adjust Up.

NOTE: Use all products according to directions on the bottle. **NOTE:** Salt systems naturally drive pH levels to increase, strive to achieve a Balanced pH level.

NOTE: High pH will cause calcium to precipitate (fall out of suspension). The problem with calcium falling out of suspension is that it collects on the heater and pump, and shortens their life.



Step 3. Mix Salt Crystals

Dissolve 1/3 of the minimum recommended salt dosage in a 5 Gallon (20

litre) pail of hot water.

Refer Arctic Spas – Onzen Salt Dosage Chart contained in this guide.

1.11.3 Establishing Correct Water Chemistry

The following steps provide guidance to help establish correct chemically balanced water.

To help ensure chemicals dissolve appropriately it is good practice to first mix/dissolve the chemical in an uncontaminated container of hot water before carefully adding to the spa water.

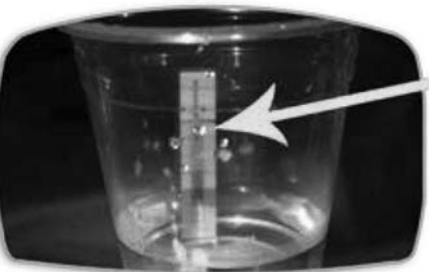
Steps to Establish Chemically Balanced Water With Onzen Continued					
	<p>Step 4. Add Salt to Spa Water & Test TA / pH</p> <p>(a) Slowly pour the dissolved salt from the pail into the spa water. (b) Run pumps for 5 minutes to help mix salt blend through.</p> <p>(c) Wait 1 hour.</p> <p>(d) Then test and adjust Total Alkalinity level accordingly.</p> <p>(e) Then test and adjust pH level accordingly.</p> <p>Refer to steps 3 and 4 for correct TA/pH levels.</p>				
	<p>Step 5. Repeat Step 3 & 4</p> <p>Repeat steps 5 and 6, ensuring all sub steps are carried out accordingly.</p> <p>Step 6. Repeat Step 3 & 4</p> <p>Repeat steps 5 and 6, ensuring all sub steps are carried out accordingly.</p>				
	<p>Step 7. Test Sodium Chloride Level</p> <p>You will now need to test sodium chloride levels.</p> <p>Refer 'Using Sodium Chloride Test Strips' for details.</p> <p>If sodium chloride levels are low, dissolve 1/2 lb (225 Grams) of salt (using cup provided) into hot water. Pour the dissolved salt into the spa water. Test sodium chloride level.</p> <p>Repeat until required sodium chloride level is reached:</p> <table border="1" style="width: 100%; text-align: center;"> <thead> <tr> <th style="background-color: #ccc;">Minimum</th> <th style="background-color: #ccc;">Maximum</th> </tr> </thead> <tbody> <tr> <td>2000 ppm</td> <td>2500 ppm</td> </tr> </tbody> </table> <p>Note: The Arctic Spas Onzen Salt Chart in this guide provides the estimated impact of adding 1/2 lb (225 Grams) of salt to your spa.</p> <p>Note: For start up it is recommended to strive for the minimum salt dosage. Once a Sodium Chloride reading has been taken and the minimum salt dosage achieved, it can be increased slightly to accommodate spa usage and bather load, if increasing the Onzen run time does not adequately increase the Chlorine Residual. Having the minimum amount of salt concentration unless the Onzen system is unable to maintain the proper Chlorine Residual, will reduce potential corrosion and increase the life of the Onzen Output Electrode.</p>	Minimum	Maximum	2000 ppm	2500 ppm
Minimum	Maximum				
2000 ppm	2500 ppm				

ONZEN OWNERS MANUAL

1.11.4 Arctic Spas Onzen Salt Dose Guidance Table

The following table identifies the salt quantity required for each Arctic spa model and estimated impact of adding half pound (225g) of salt.



For start up it is recommended to strive for the minimum salt dosage. Once a Sodium Chloride reading has been taken and the minimum salt dosage achieved, it can be increased slightly to accommodate spa usage and bather load, if increasing the Onzen run time does not adequately increase the Chlorine Residual. Having the minimum amount of salt concentration unless the Onzen system is unable to maintain the proper Chlorine residual, will reduce potential corrosion and increase the life of the Onzen Output Electrode.

Arctic Spas - Onzen Salt Dosage Chart								
Spa Model	Water Volume Metered Fill Point (Bottom of Head Rest)		Required Salt Dosage Onzen Version 8				Estimated Impact of Adding Extra Salt	
	Litres	US Gal	Min Kg	Max Kg	Min Lb	Max Lb	225 Grams	1/2 lb
Fox	875	231	1.06	1.32	2.34	2.92	255 ppm	255 ppm
Glacier	1131	299	1.37	1.71	3.02	3.78	195 ppm	195 ppm
Cub	1176	311	1.43	1.78	3.14	3.93	190 ppm	190 ppm
Klondiker	1264	334	1.53	1.91	3.38	4.23	175 ppm	175 ppm
Frontier	1267	335	1.53	1.92	3.39	4.24	175 ppm	175 ppm
Summit	1339	354	1.63	2.03	3.59	4.48	165 ppm	165 ppm
Yukon	1364	360	1.66	2.07	3.65	4.56	163 ppm	163 ppm
Kodiak	1492	394	1.81	2.26	3.99	4.99	150 ppm	150 ppm
Tundra	1614	426	1.96	2.45	4.32	5.40	138 ppm	138 ppm
Norwegian	1553	410	1.89	2.36	4.16	5.20	144 ppm	144 ppm
Ocean	6000	1585	7.28	9.10	16.00	20.08	37 ppm	37 ppm

Note: The Onzen Technical Guide provides supportive procedures for Onzen set up and Onzen settings.

1.11.5 Using Sodium Chloride Test Strips

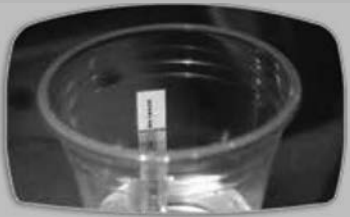
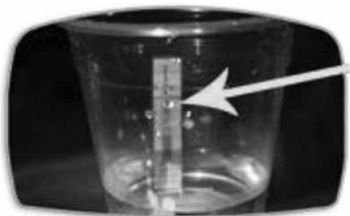
The following steps provide guidance to help ensure sodium chloride test strips are used correctly.

Steps to Help Ensure Sodium Chloride Test Strips are Used Correctly	
	<p>Step 1. Take Water Sample Take a sample of water from the spa in a small cup (about 25mm / 1" full). NOTE: Always take water samples 25-30cm (12"-18") below the water surface.</p>
	<p>Step 2. Place Test Strip in Water Sample Place the lower end of the strip into the water. IMPORTANT Keep top half of strip COMPLETELY dry to get an accurate reading.</p>
	<p>Step 3. Test Duration Period Leave strip in water for 3 – 5 minutes until yellow band at top of strip turns dark.</p>
	<p>Step 4. Obtain Readings Obtain your reading: where top of white peak falls on the number scale. Read top of peak to the nearest 0.2 division.</p>
	<p>Step 5. Correspond Test Result Reading Correspond the test result reading number with the numbers on the bottle.</p>

Steps to Help Ensure Sodium Chloride Test Strips are Used Correctly Continued



Step 6. Sodium Chloride Adjustment

The following levels are ideal:

Minimum	Maximum
2000 ppm	2500 ppm

Note: The Arctic Spas Onzen Salt Chart in this guide provides the estimated impact of adding 1/2 lb (225 Grams) of salt to your spa.

Add or dilute water as needed.

- If Sodium Chloride reading is greater than the maximum level, add water.
- If Sodium Chloride reading is less than the minimum level, add salt.

Note: Once Sodium Chloride reading is in the ideal range salt concentration will only change if water is splashed or drained out and spa is replenished with water. Do not add salt unless this test confirms the level is below the ideal range.

Warranty: Use of salt other than Arctic Pure sea salt blend will damage the components and void the warranty. The Arctic Pure blend has been developed to protect Onzen components from damage and the use of alternative salt blends will be easily detected by technicians.

Steps to Stabilize Water



Step 1. Stabilize Spa Water

Once Filtration cycles and filtration duration low level settings have been programmed place the insulated cover on the spa and allow the water temperature to stabilize (approximately 16 hours). Make sure you secure the cover in place using the cover locks. Periodically check the spa water temperature. When the water temperature climbs above 85°F, (29°C) proceed to the next step.

Note: As heat impacts both Calcium and Total Alkalinity a little it is best to heat the water above 29°C (85°F) before advancing to Establishing Correct Water Chemistry.















Filter Cycle Suspension

During a Filter cycle, if an accessory (a pump, the blower, or the light) is used manually, the Filter cycle is suspended during the time that the accessories are used.

Once all accessories are turned off (whether manually or by built-in timer), the Filtration cycle remains suspended for an extra 40 minutes. When a Filtration cycle is suspended the Filtration cycle icon will blink.

1.11.6 Program Filtration & Onzen Settings

The Onzen Chlorine Production (Onzen Cycle Duration) settings need to be programmed: The following steps provide guidance on how to program the Onzen system settings:

Steps to help Set Filtration & Onzen Settings	
	<p>Step 1. Enter Filtration Options Through Topside Controller</p> <p>Press the Filter button (pump 5 on epics)   to enter into your filtration options. Your display will show "SETT" and from here you will be able to choose your settings.</p>
 	<p>Step 2. Ozone Cycle Duration Through Topside Controller</p> <p>Press your Filter/Pump 5 button   again to display your first option. This is your Ozone Cycle Duration.</p> <p>* Peak II only, if Peak 1 is installed ozone will run during filtration.</p> <p>Step 3. Setting Ozone Duration Through Topside Controller</p> <p>Use your arrow keys   to select your Ozone Cycle Duration. You can select from 1 to 24 hours per day.</p>
	<p>Step 4. Enter Onzen Settings Through Topside Controller</p> <p>Press your Filter/Pump 5 button   again until you see On02.</p> <p>Your display will now show the settings for your Onzen system.</p>
	<p>Step 5. Onzen Cycle Duration</p> <p>Use your arrow keys   to select your Onzen Cycle Duration.</p> <p>You can select from 1 to 24 hours per day.</p> <p>* Cycles are divided into 4 ie: If 8 hours is selected, the system will perform 4 x 2 hour cycles per day.</p>

Steps to help Set Filtration & Onzen Settings Continued



Step 6. Filter Duration

Press your Filter/Pump 5 button  again.
Your display will now show the settings for your Filter Duration.



Step 7. Setting Filter Duration

Use your arrow keys   to select your Filter Duration in hours.

You can select from 0 to 6 hours, the number of hours your filtration will run each time.



Step 8. Filter Cycle Frequency

Press your Filter/Pump 5 button  again.
Your display will now show the settings for your Filter Cycle Frequency.



Step 9. Setting Filter Cycle Frequency

Use your arrow keys   to select your Filter Cycle Frequency

You can select from 1 to 4 times per day.











You can move backwards through the settings by pressing the Pump 3 button (Pump 4 on Epic series spas). The Pump 1 button will allow you to exit without saving any changes. When you get to the end of the options, press the filter key one last time to save changes and begin a filter cycle immediately. If you do not press the filter key again your changes will be saved and the filter cycle will begin when you have programmed it to do so.

* Press your Filter/Pump 5 button  again to start the next cycles immediately (Pumps will purge for 20 seconds).

To EXIT without saving changes press Pump 1.

To SAVE & EXIT but not start the cycle simply let the display time out.

1.11.7 Conducting a Sanitizer Production Test

Is Sanitizer Being Produced and Delivered to Spa Water?	
<p>This test requires:</p> <ul style="list-style-type: none"> · The water temperature to be at least 80o F (27o C). · The Filter Cycle Duration to be set to 00. · Onzen Cycle Duration programmed to On 24. Onzen system will run for 24 hours per day. 	
	<p>Step 1. Set Filtration Cycle Time to Fd 00 (= No Filtration)</p> <p>Press the Filter Cycle   Key until SETT is displayed. The Filter Cycle Duration details "Fd" will be displayed "Fd XX" .</p> <p>Use down arrow  key to change the Filter Cycle Duration to Fd 00. This de-activates the filtration pump so you can see the mist of gas bubbles produced by the Onzen System.</p>
	<p>Step 2. Scroll to On (Onzen Duration) Setting</p> <p>Scroll through the settings by pressing the Filter Cycle</p> <p>  key until it reads "On X ". ("x" will be a value between 0 & 24).</p>
	<p>Step 3. Change On Setting to On 24</p> <p>Change On setting to On 24.</p> <p>On 24 programs the Onzen system to produce sanitizer 24 hours daily.</p>
	<p>Step 4. Scroll Through Settings</p> <p>Continue scrolling through the settings by repeatedly pushing the Filter Cycle   key until the pack resets.</p>

Steps to help Set Filtration & Onzen Settings Continued



Step 5. Software Revision

The software revision will flash for 5 seconds.

If any keys are pushed at this stage, you will need to re-start the test from step 1.

* The pack will go through a purge cycle, turning on all pumps for 20 seconds. Wait until this is complete and the water is still.

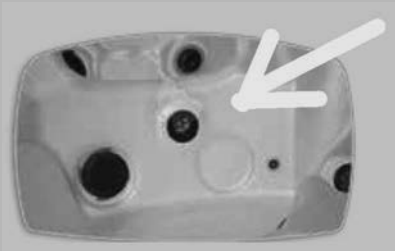

Step 6. Confirm Onzen Output Electrode is Releasing a Fine Mist of SMALL Bubbles

Before touching any spa control keys, locate the Onzen Output Electrode in the foot well of the spa. There should be a fine mist of small bubbles coming from the fitting within a minute or two.

If no bubbles are visible, dealer service may be required.

Note: You can still sanitize your spa with granular chlorine!

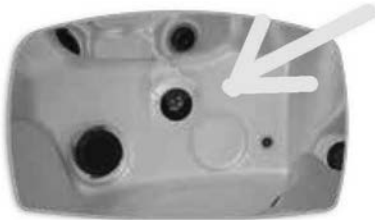

Step 7. Allow to Produce Sanitizer

If you see bubbles, sanitizer is being produced.

Leave the Onzen system to produce sanitizer for the next few hours and make sure it does not shut off.

If you do not see these "fine misty small bubbles" call for service.



Step 8. Reset Filtration Settings

a. After a visual check, you can reset your Filter Cycle Duration. Fd 1 is suggested.

b. Then reset your desired temperature.

1.11.8 Sanitizer Readings

The following provides guidance on the establishment and maintenance of sanitizer readings.



Sanitizer Readings

You should have sanitizer (Chlorine) readings within 24 hours.

On Start-up, you can add one capful of Arctic Pure "Boost" to the spa water.

Adding a capful of Arctic Pure Boost (Stabilized Chlorine) will establish an instant Free Chlorine level while the Onzen system is producing the residual. This will allow you to safely use the spa until an adequate residual is established.

If levels get too high, turn Sanitizer Production setting down. If you are not getting any readings, turn Sanitizer Production up.

The closer you monitor spa usage, bather load, monitor FCL and adjust Onzen Sanitizer Production Levels accordingly the less sanitizer you will need to add to your spa water.

Use Arctic Pure, Boost to sanitize the water after heavy usage, or if the Chlorine level is too low.

Important: Always test and balance the pH and Chlorine levels before each spa use.

* Expect the pH to increase slowly over each week and when it gets too high use Arctic Pure, Adjust Down to correct it.

High Ph will cause premature failure of the system, cloudy water, and decreased effectiveness of the sanitizer.

The Onzen system works best with low levels of calcium. Check your calcium hardness levels monthly to ensure long life of the spa equipment and maximum user enjoyment.

You must use an oxidizer treatment Arctic Pure, Refresh in your spa. once a week and after heavy bather loads, add one cap of Arctic Pure, Refresh to your spa, leave the cover open for a minimum of 20 minutes to allow the oxidizer gas to vent. A high concentration of trapped oxidizer gas, which may exist as a result of the shock treatment, may eventually cause discoloration or vinyl degeneration to the bottom of the cover. this type of damage is considered chemical abuse and not covered under warranty.

1.12 Onzen Cloudy Water Troubleshooting Flowchart



I have an Onzen System and my water is cloudy

NOTE:
All checks and tests should be carried out in accordance with this Arctic Spas® Onzen Guide.

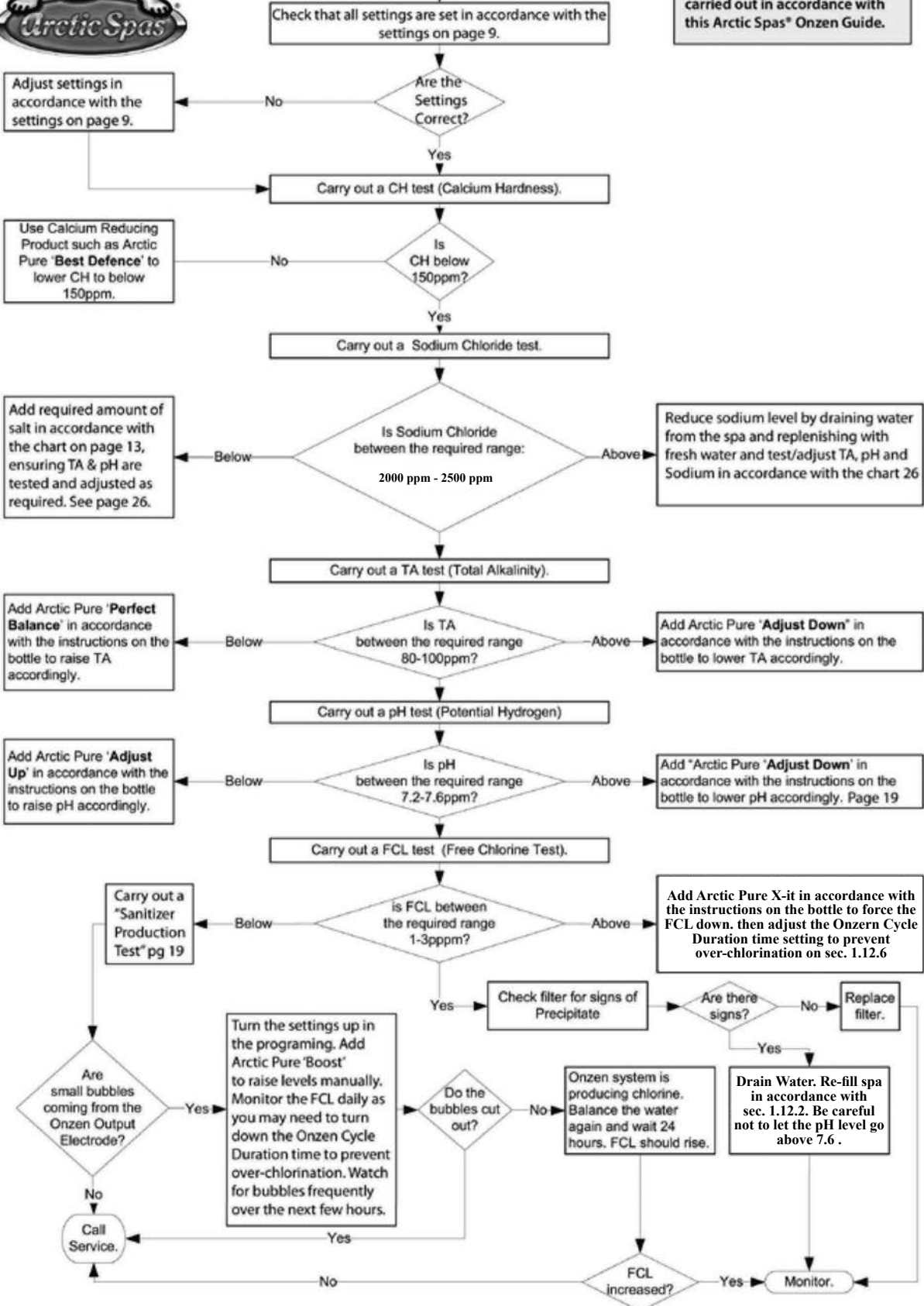

1.13 Onzen Frequently Asked Questions

Onzen Questions

Question 1: How do I know if the Onzen system is working?

Conduct a "Sanitizer Production test" (Also known as a Smoke test).

This procedure activates the Onzen System while de-activating the filtration pump so you can see the mist of gas bubbles produced by the Onzen System.

Question 2: What should I do if it fails the "Sanitizer Production test"?

First, confirm you have the correct concentration of salt in the water "using sodium chloride test strips". Then, start maintaining your water manually using "Boost" granular chlorine to sanitize and Adjust Up/Adjust Down to balance pH. Continue to do this daily until the system is repaired by an authorized service technician.

* Keep enjoying your hot tub!

Question 3: What should I do if the chlorine levels are too high?

Turn the Onzen Output down (decrease "On" settings).

Unless you added granular chlorine or shock to the water high chlorine levels mean the system is staying on too long for your circumstances. It may take a day or two for levels to normalize, or you can speed this process up by using a chlorine neutralizer, such as "X-it".

Question 4: What should I do if the pH keeps increasing?

Confirm that your Total Alkalinity is at the recommended level and reduce it manually with 'Adjust Down'. This is normal; all spa salt systems cause pH to increase.

Question 5: Will the salted water damage my lawn?

This is very unlikely.

The recommended concentration of salt is used is approximately 10% of the concentration of sea water.

Question 6: Why is my water bright yellow, or bright green, or a rusty colour suddenly?

This can happen if the pH gets too high.

Lower the pH using 'Adjust Down'. High pH is a sign that the Onzen Output may be turned up too high, so you may need to adjust the Onzen Output After balancing the pH and adjusting the Onzen Output wait about 48 hours. If the colour of the water does not normalize you may need to replace the water.

* Keep an eye on the pH and adjust it weekly to avoid this problem in the future.

Question 7: What is the typical amount of maintenance I need to do with Onzen?

1. Change the water twice a year.
2. Change the filter 4 times a year.
3. Check the Total Alkalinity weekly to make sure it is in the target range (Under 100).
4. Adjust the pH once a week. Salt systems naturally drive pH levels to increase, strive to achieve a Low pH level 7.2
must not exceed 7.6.
5. Check Calcium level monthly to ensure it is in the target range. Salt systems perform best with Low Calcium levels;
strive for a target range between 50 - 150 ppm.
6. Adjust the Onzen Output "On" if hot tub use changes significantly.
7. Adjust the chlorine levels using "Boost" granular chlorine, after heavy use or if the Onzen Output is too low. Refer: Onzen Maintenance Schedule for further details.

Onzen Questions Continued

Question 8: What should I do if the spa is not going to be in use or when I go on vacation?

(please see FAQ #3)

Question 9 Should I use Best Defence or another scale remover?

It is recommended that calcium be removed from the water in advance rather than adding a scale remover after the fact.

Question 10: What is the impact of phosphates on the Onzen system?

High levels of phosphates (above 250 ppb) may reduce the effectiveness of sanitizer output. Question 13 What happens if my water becomes cloudy?

1. Test the water for chlorine content. If the level is low add Boost.
2. Check your filters as they may require replacement.
3. Check your pH level you may need to adjust you pH down.

Question 11 : Can I use softened water with my Onzen system?

Yes. You probably have a water softener because your water is quite hard. Your water-softener removes calcium from your water and helps you achieve water with calcium content near the target range, between 50 - 150 ppm.

Question 12: Prior to draining spa water for refill purposes should any form of system flush be carried out?

Yes you can, Arctic Pure 'Fresh Start'. Use in accordance with the instructions on the container. Flushing the system components and hoses is helpful when you get biofilm and calcium build-up.

It is good practice to do this at least once a year.

*** IMPORTANT NOTICE ONZEN V8 ***

These cells are considered a consumable item and are now designed to be replaced by the customer in order to be more user friendly. DO NOT GET THE INTERNAL CONNECTION WET!

To change your salt cell remove the set screw on your salt cell with a Phillips screwdriver. Now unthread the salt cell from the housing turning counter clockwise. This will require you to use your muscles as the cell is threaded in quite tight to prevent any water from getting on to the 12 volt connection. Before threading in the new cell put a generous amount of dielectric grease in and around the 12 volt connections in the centre of the housing and on the end of the cell. Now thread the new cell into the housing. There is a notch built into the threads that will stop the cell precisely where the set screw needs to be installed. If the cell is changed under water the connection will get wet and corrode. The corrosion will destroy the connection between the salt cell and the salt cell housing. This corrosion will be visibly noticeable upon inspection. Warranty will be void If corrosion between the salt cell and salt cell housing is detected.

1.14 Arctic Spas Onzen Maintenance Schedule

The following table outlines the typical water maintenance program required for an Arctic Spa fitted with Onzen.

To help ensure chemicals dissolve appropriately it is good practice to first mix/dissolve the chemical in an uncontaminated container of hot water before carefully adding to the spa water.

Item	Frequency	Maintenance Task	Target Range
TA	Weekly	Check the Total Alkalinity to ensure it is in the target range.	80 – 100 ppm.
pH	Weekly	Check the Potential Hydrogen to ensure it is in the target range.	7.2 – 7.6 ppm
FCL	Weekly (& before eachuse)	Check the Free Chlorine Level to ensure it is in the target range. Adjust the chlorine levels using “Boost” granular chlorine, after heavy use or if the Onzen Output is too low	1 – 3 ppm
ORP	Refer FCL	Refer FCL Maintenance Task	600–1000 mV
CH	Monthly	Check Calcium Hardness level to ensure it is in the target range. Salt systems perform best with Low Calcium Hardness levels.	50-150 ppm
Sodium Chloride	Monthly	Check the Sodium Chloride Level to ensure it is in the target range.	Version 8 2000-2500 ppm
Onzen Output	As required	If spa use changes significantly, adjust the output level of Onzen Chlorine Production (“On”)	2 - 4 Hours per day suggested
Filter	Every 3 Months	Change the filter	N/A
Water	Every 6 Months	Change the water	N/A

Note: It is also good practice to take a water sample on a regular basis and have the water independently tested by your local spa/pool store.

Maintenance	
	Low TA - Can be raised by adding Arctic Pure, Perfect Balance to spa water. High TA - Can be lowered by adding Arctic Pure, Adjust Down to spa water.
	Salt systems naturally drive pH levels to increase, strive to achieve a Low pH level 7.2. pH must not exceed 7.6. Low pH - Can be raised by adding Arctic Pure, Adjust Up to the spa water. High pH - Can be lowered by adding Arctic Pure, Adjust Down to spa water.
	Low FCL - Can be raised by adding Arctic Pure, Boost and or turning Onzen Cycle Duration (Chlorine Production On) Level up. High FCL - Can be lowered by: <ul style="list-style-type: none"> • Natural cause over a few days. • Turning Onzen Cycle Duration (Chlorine Production On) down. • Adding Arctic Pure, X-it. The above is dependent on FCL level, spa usage and bather load.
	Refer FCL Maintenance Action to Adjust/Correct.
	High CH - lower with a stain & scale controller such as Arctic Pure, Best Defence, to help hold Calcium in suspension.
	Once Sodium Chloride reading is in the ideal range salt concentration will only change if water is splashed or drained out. Do not add salt unless this test confirms the level is below the chemical target range. High Sodium Chloride - add water. Low Sodium Chloride - add salt.
	Go into low level settings and adjust Onzen Cycle Duration (Chlorine Production On) accordingly. Adjust to suit spa usage and bather load.
	Change the filter in accordance with Owners Manual instructions
	Change the water in accordance with Owners Manual instructions.

OWNERS MANUAL

BEAR ESSENTIALS CLASS & CORE SERIES

SPA SPECIFICATIONS

	Outside Dimensions	Heights	Heater (Watts)	Water Capacity	Dry Weight	Electrical Requirements North America	Electrical Requirements Europe
CHURCHILL	93"x93" 235cm x 235cm	39" 99 cm	NA / Euro 4000 W	463 Gallons 1753 Litres	765 Lbs 347 Kg	240 Volt, 50 Amp	1 phase x 32Amp or 3 phase x 16Amp
LAURENTIAN	93"x93" 235cm x 235cm	39" 99 cm	NA / Euro 4000 W	380 Gallons 1438 Litres	763 Lbs 346 Kg	240 Volt, 50 Amp	1 phase x 32Amp or 3 phase x 16Amp
MALIGNE	86"x86" 218cm x 218cm	41" 104 cm	NA / Euro 4000 W	375 Gallons 1420 Litres	734 Lbs 333 Kg	240 Volt, 50 Amp	1 phase x 32Amp or 3 phase x 16Amp
BAFFIN	86"x86" 218cm x 218cm	41" 104 cm	NA / Euro 4000 W	333 Gallons 1260 Litres	802 Lbs 364 Kg	240 Volt, 50 Amp	1 phase x 32Amp or 3 phase x 16Amp
TIMBERWOLF	75.5"x86" 192cm x 219cm	37" 94 cm	NA / Euro 4000 W	272 Gallons 1030 Litres	630 Lbs 286 Kg	240 Volt, 50 Amp	1 phase x 32Amp or 3 phase x 16Amp
AURORA	81"x81" 206cm x 206cm	39" 99 cm	NA / Euro 4000 W	315 Gallons 1193 Litres		240 Volt, 50 Amp	1 phase x 32Amp or 3 phase x 16Amp
GRIZZLY	91"x91" 231cm x 231cm	39" 99 cm	NA / Euro 4000 W	375 Gallons 1420 Litres		240 Volt, 50 Amp	1 phase x 32Amp or 3 phase x 16Amp
ORCA	91"x91" 231cm x 231cm	39" 99 cm	NA / Euro 4000 W	400 Gallons 1514 Litres		240 Volt, 50 Amp	1 phase x 32Amp or 3 phase x 16Amp
OTTER	46"x86" 117cm x 218.5cm	29.5" 75 cm	NA / Euro 4000 W	150 Gallons 568 Litres		240 Volt, 50 Amp	1 phase x 32Amp or 3 phase x 16Amp

in.ye overview

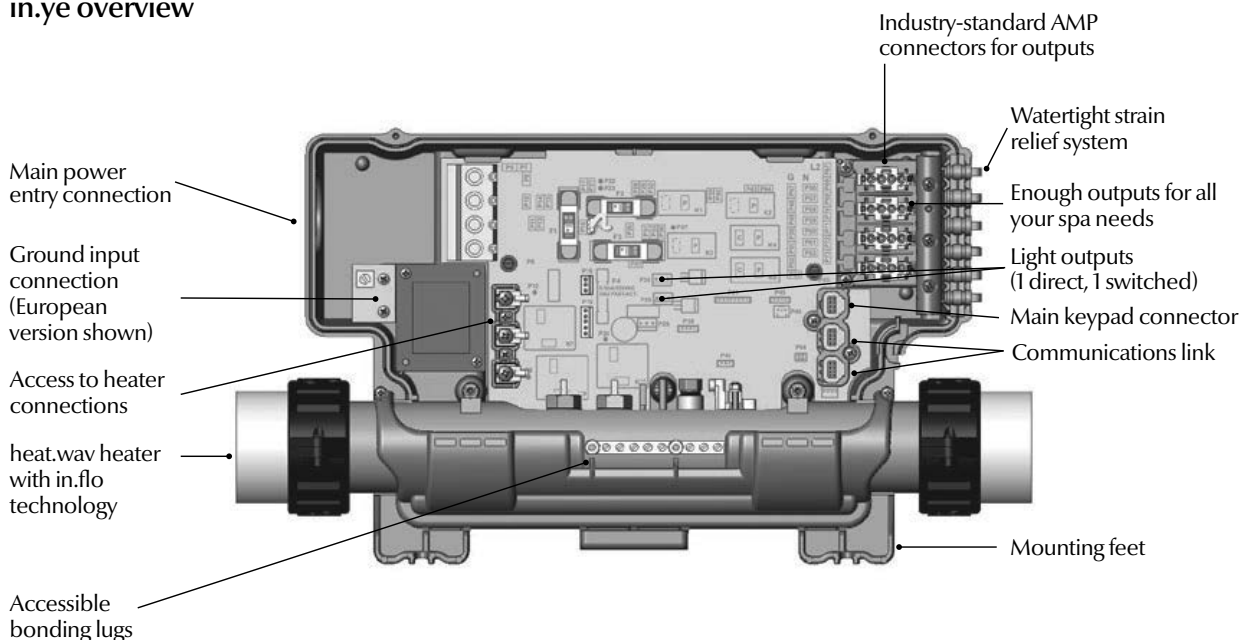

in.ye dimensions

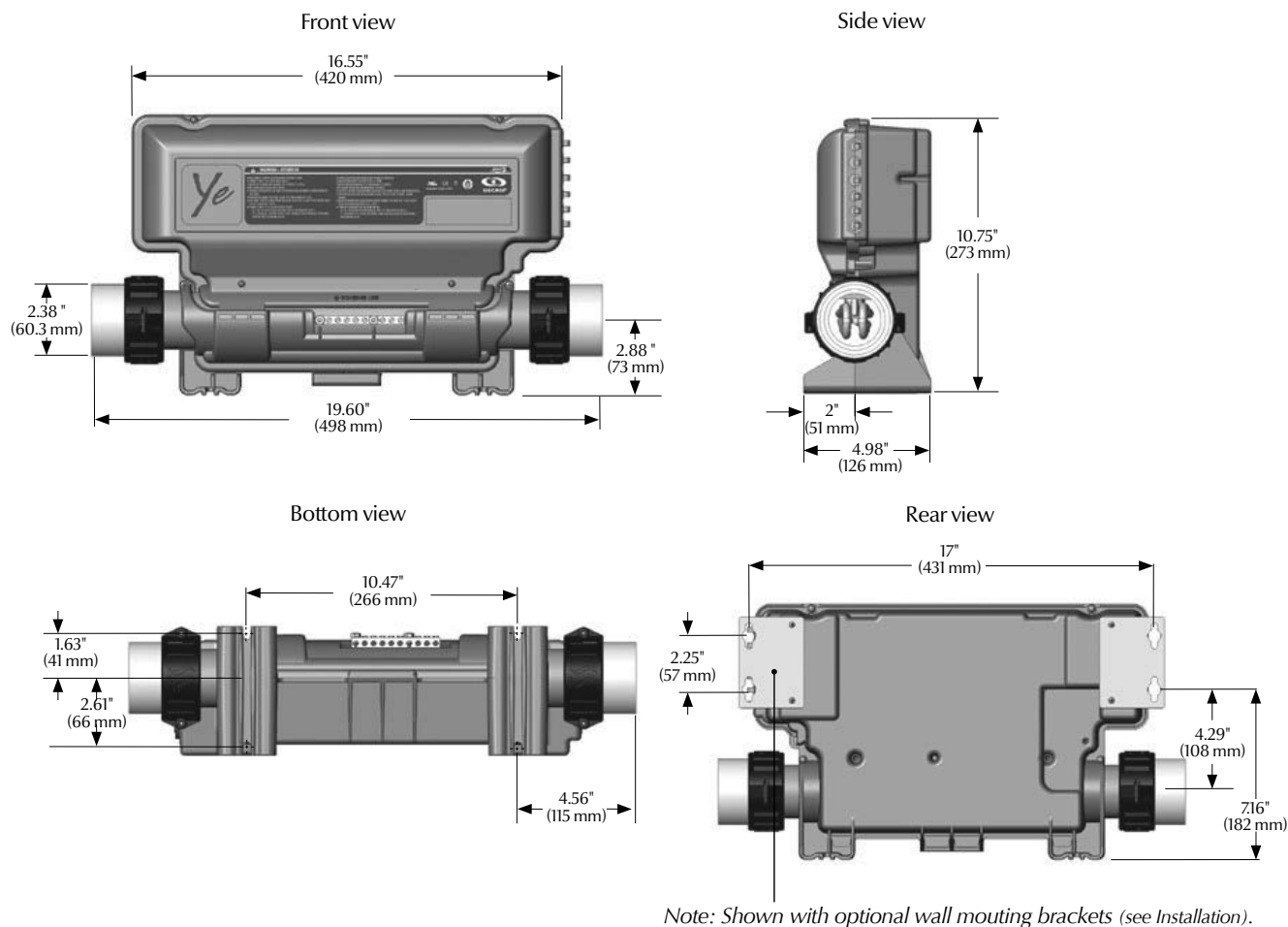

Keypad installation

See the techbook for your specific keypad model for installation details and drilling template.

Connecting the main keypad to the spa pack

To connect the keypad, remove the cover, then insert the in.link connector into the appropriate keypad connector (as illustrated). Route the cable through one of the molded strain relief channels on the bottom right side of the spa pack (as illustrated). Fill the remaining space with the foam gaskets supplied. Don't forget to replace the cover and all screws (torque to 8 in.lb max [0.9 N.m]).

Note: always shut power down before connecting an accessory to the in.ye

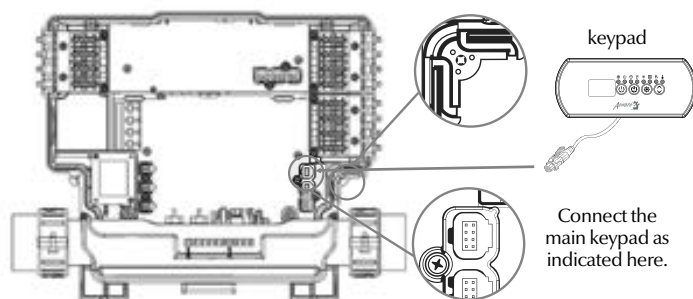

Y Series connections

Electrical wiring for North American models

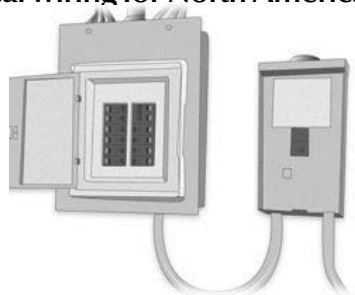

Main electrical box GFCI panel

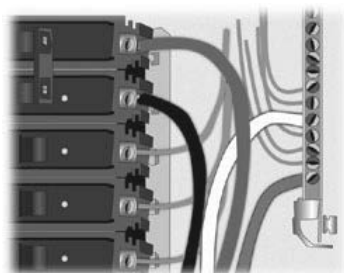

Warning!

For units for use in other than single-family dwellings, a clearly labeled emergency switch shall be provided as part of the installation. The switch shall be readily accessible to the occupants and shall be installed at least 5' (1.52 m) away, adjacent to, and within sight of the unit.

This product must always be connected to a circuit protected by a ground fault interrupter.

Proper wiring of the electrical service box, GFCI and in.yt terminal block is essential!

Check your e'e terminal block is essential! itions. Only copper wire should be used, never aluminum.

Disposal of the product

The appliance (or the product) must be disposed of separately in accordance with the local waste disposal legislation in force.

Electrical wiring for all models

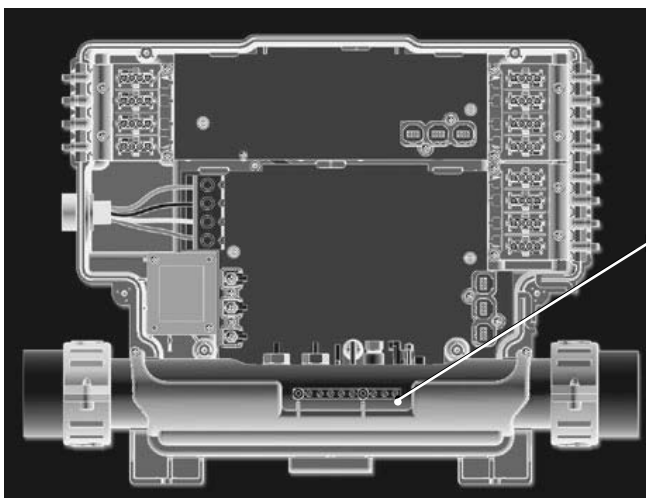

Bonding lug

To install the wiring for the Y Series spa control, you'll need a Phillips screwdriver and a flat screwdriver.

Loosen the screws of the spa pack cover and remove it. Remove 5 1/2" (142 mm) of cable insulation. Strip away 1" (25 mm) of each wire insulation. Pull the cable through the cutout of the box and secure it with a strain relief (1" NPT strain relief; hole diameter: 1.335" [33.9 mm]).

(For CE use an IEC certified plastic bushing that will maintain the IPX5 rating.)

Make sure that only the uncut sheathing is clamped at this opening. Make sure that the terminal block case

clamps are lowered before inserting wires. Push the color-coded wires into the terminals as indicated on the sticker and use the flat screwdriver to tighten the screws on the terminals.

After making sure wire connections are secure, push them back into the box and replace the cover. Tighten the screws of the spa pack cover. Do not over tighten cover screws (torque to 8in.lb max [0.9 N.m]).

Connect the bonding conductor to the bonding lug on the front of the Y Series spa pack (a grounded electrode conductor shall be used to connect the equipment grounding conductors).

Electrical wiring: North American model

Refer to wiring diagram in the enclosure box lid for more information.

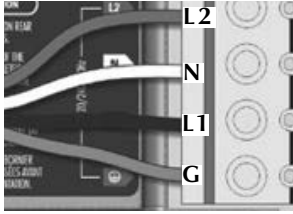

For 240 V (4 wires)

Correct wiring of the electrical service box, GFCI, and pack terminal block is essential.

Call an electrician if necessary.

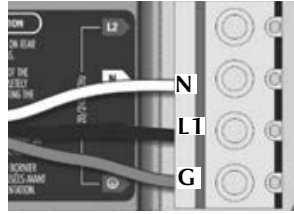

For 120 V (*3 wires)

*If connected to a 3 wire system, no 240 V component will work.

Note: To convert model to a 120 V system, the white (common) accessory wire must be moved. See wiring diagram for details.

Electrical wiring: in.ye European model

Refer to wiring diagram in the enclosure box lid for more information.

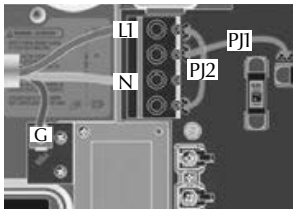

1-phase

Connect PJ1 between P7 and P13. Connect PJ2 between P10 and P74.

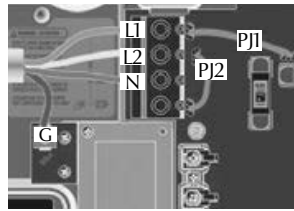

2-phase with single neutral

Connect PJ1 between P7 and P10. Connect PJ2 between P13 and P74.

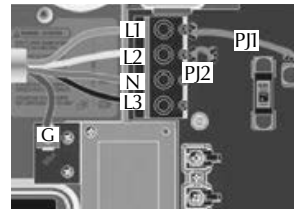

3-phase with single neutral

Connect PJ1 between P7 and P10. Connect PJ2 between P11 and P13.

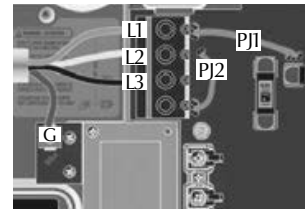

3-phase Delta

Connect PJ1 between P7 and P10. Connect PJ2 between P13 and P74.

In.ye.ce 230 V or 230/400 V

Correct wiring of the electrical service box, RCD, and pack terminal block is essential!
Call an electrician if necessary.

Warning!

In.ye.ce models must always be connected to a circuit protected by a Residual-Current Device (RCD) having a rated operating residual-current not exceeding 30 mA.

Heater connections

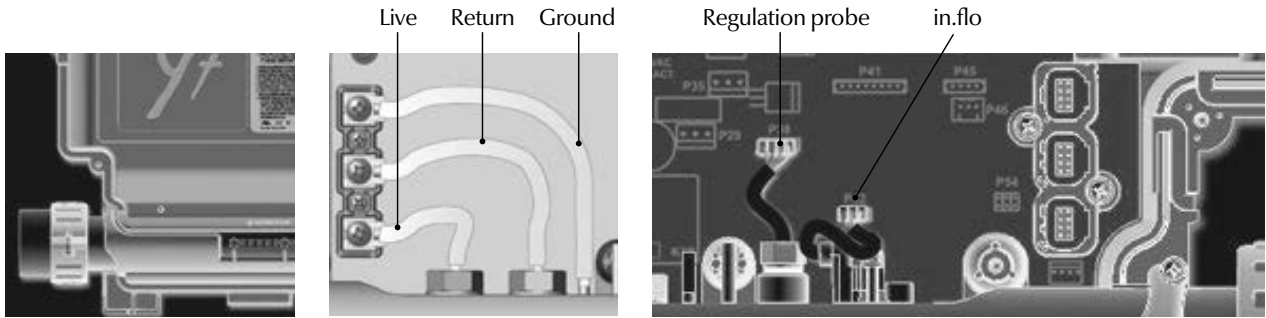

heat.wav heater

All Y Series systems come with a high performance heat.wav heater. With no pressure switch, it features in.flo integrated dry-fire protection.

The heat.wav heater is factory configured for 240 V / 4 kW, but it can be converted to a dedicated 120 V / 1 kW by simply adding a cable connection (Part #: 9917-101959). (120 V conversion is available on North American in.ye-3 models only).

heat.wav specification summary:

- Supports 120 V or 240 V
- Protected by external breaker (not fused)*
- Incoloy® heater element
- Optional 5.5 kW (Part #: 9920-101449), 240 V heater is available.

**Note: European models are 230-240 V only, and are fuse protected*

All heater connections are accessible when the cover is removed. Connections include the in.flo dry-fire protection, hi-limit/regulation probe connectors, power and ground cable connections.



Connections for all 240 V heaters (North American installations only)

BROWN wire must be correctly and completely connected between P12 and P9.

For early North American version installations the YELLOW wire must be between P25 and P20. the ORANGE wire must be between P24 and P16

Connections for all 120 V heaters

BROWN wire must be correctly and completely connected between P12 and P10.

Note: To convert model to a 120 V system, the white (common) accessory wire must be moved. See wiring diagram for details.

Power-up & breaker setting

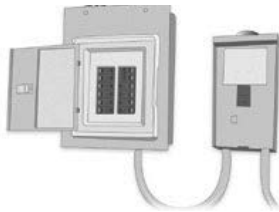

IMPORTANT! Read before starting

Turn off the breaker.

Make sure all accessories are linked to the bonding connector and connected to pack.

A minimum flow rate of 18 GPM is required. Make sure that all valves are open in the spa plumbing and that you have good water flow circulation from the primary pump into the heater.

Turn on the breaker.

in.flo dry-fire protection

At power up, the in.flo detector performs a flow check through the following process:

Pump 1 or circulation pump starts for 2 minutes.

The display will show " _ " during the check flow process. After 2 minutes the system validates proper water flow.

In case of failure, the system tries again. The water temperature is shown on the keypad display. Once the water has reached the set point value plus 0.8°F the heater is turned off.

Boot up display sequence (Each parameter is displayed for 2 seconds)



Lamp test

All the segments and LEDs light up.

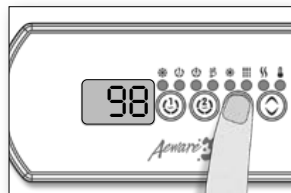

It's important to specify the current rating of the GFCI used to ensure safe and efficient current management (and reduce nuisance GFCI trippings).

Press and hold the **Prog** button until you access the breaker setting menu (programming menu will appear first).

Note: if the keypad in use does not have the **Prog** key, use the **Light** key instead.



Software number

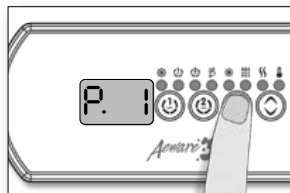

Choose the number of phases supplying your spa. Use the **Up/Down** key to choose the desired value and press the **Program** or **light** key to confirm the selection. You can choose between 1, 2 or 3 phases.

Number of phase selection

UL	Menu not available
CE	1, 2 or 3
UL Swim*	1 or 2
CE Swim*	1, 2 or 3

*See Swim Spa manual for details.

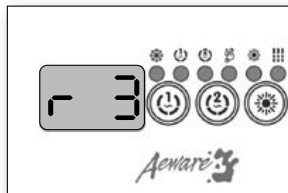

Software revision



The values displayed by the system correspond to 0.8 of the maximum amperage capacity of the GFCI.

Use the **Up/Down** buttons to select the desired value.

The value can typically be modified from 10 to 48 A.

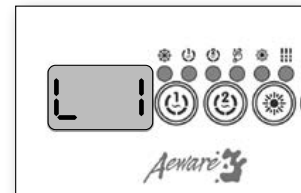

Low-level selection

Low-level selected from low-level menu



Press the **Prog** button to set breaker rating. This table shows typical settings of **b** for different GFCI ratings. Select the one that matches your breaker.

GFCI	b
60 A	48 A
50 A	40 A
40 A	32 A
30 A	24 A
20 A	16 A

Note: Every OEM has its own preset configurations.

High voltage accessory connections

Two options are available with Y Series spa packs for connecting high voltage accessories: 0.250" quick-connect terminals, or AMP pins and housings.

in.ye

These tabs require high-voltage accessories to have straight, non-insulated, female quick-connect terminals for all connections, including ground. Depending on where the connections are made on the in.ye pack PCB, 120 V and 240 V accessories are supported. Refer to the following tables for correct connections. Note that all female terminal must be correctly and completely seated on the PCB tab for proper current ratings.

Generic in.ye-3-V2 UL configuration			
Config \ Slot	A1	A2	A3
SKU OUT H	K1-P	K2-P	K4-P
	OUT 4	OUT 5	OUT 2
SKU OUT L	--	--	K2-P
	--	--	OUT 5
Typical	03/CP	--	P1,2sp
1	--	03	P1,2sp
2	P2,1sp	03	P1,2sp
N.A.			

Generic in.ye-3-V2 CE configuration			
Config \ Slot	A1	A2	A3
SKU OUT H	K2-P	K4-P	K1-P
	OUT 5	OUT 2	OUT 4
SKU OUT L	--	--	K4-P
	--	--	OUT 2
Typical	03/CP	--	P1,2sp
1	--	03	P1,2sp
2	P2,1sp	03	P1,2sp
EURO			

Generic in.ye-5-V2 UL configuration					
Config \ Slot	A1	A2	A3	A4	A0 (FL1)
SKU OUT H	K1-P	K2-P	K4-P	K6-P	K2-P
	OUT 4	OUT 5	OUT 2	OUT 3	OUT 5
SKU OUT L	--	--	K2-P	--	--
	--	--	OUT 5	--	--
Typical	03/CP	P2,1sp	P1,2sp	BL	DIR
1	03	P2,1sp	P1,2sp	Onzen	DIR
N.A.					

Generic in.ye-5-V2 CE configuration					
Config \ Slot	A1	A2	A3	A4	A0 (FL1)
SKU OUT H	K4-P	K3-P	K1-P	K6-P	Direct 1
	OUT 2	OUT 1	OUT 4	OUT 3	Dir 1
SKU OUT L	--	K6-P	K2-P	--	--
	--	OUT 3	OUT 5	--	--
Typical	03/CP	P2,1sp	P1,2sp	BL	DIR
1	03	P2,1sp	P1,2sp	Onzen	DIR
EURO					

OWNERS MANUAL - BEAR ESSENTIAL CLASS & CORE SERIES

Keypad Overview



in.k300™ Compact full-function keypad

The Quick Reference Card provides an overview of your spa's main functions and the operations accessible from your digital keypad. This QRC depicts a generic overlay, custom versions may vary.

Description

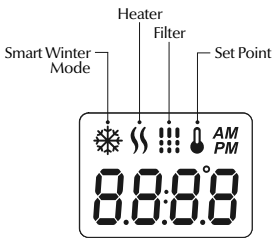

1 Pump Model

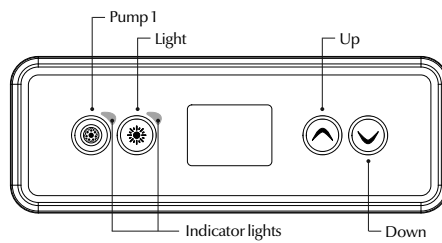

2 Pump Model

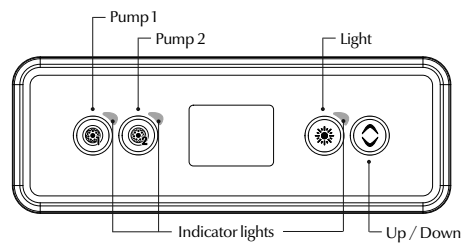

Spa Functions



Off Mode

Pressing **Pump 1** for 5 seconds will enable the Off mode. This mode allows you to stop all outputs including automatic functions such as filter cycle, heat request and smart winter mode for 30 minutes to perform quick spa maintenance. When Off mode is active, the display will toggle between the "OFF" message, the clock and the water temperature. The spa light will flash for a few seconds before the end of the 30 minutes to warn you that the system is about to resume its normal operation. Press **Pump 1** or **Pump 2** (if available) to restart the system before the expiration of the 30 minute delay. When the system resumes its normal operation, the display shows "On" for 3 seconds.



Pump 1

Press **Pump 1** key to turn Pump 1 on at low speed. Press a second time to turn pump to high speed (with a dual-speed pump*). A third time turns pump off. A built-in timer automatically turns pump off after 20 minutes, unless pump has been manually deactivated first. The "Pump 1" indicator lights up when Pump 1 is on. With a dual-speed pump, the indicator will flash when pump 1 is on at low speed.



Pump 2 key

Not available on all models. Press **Pump 2** key to turn Pump 2 on at low speed. Press a second time to turn pump to high speed (with a dual-speed pump*). A third time turns pump off. A built-in timer automatically turns pump off after 20 minutes, unless pump has been manually deactivated first. The "Pump 2" indicator lights up when Pump 2 is on. With a dual-speed pump, the indicator will flash when pump 2 is on at low speed.



Light key

Press **Light** key to turn light on. A second press turns light off. A built-in timer automatically turns light off after 2 hours, unless it has been manually deactivated first. The "Light" indicator lights up when light is on.



Up/Down keys

Use **Up** or **Down** key to set desired water temperature. The temperature setting will be displayed for 2 seconds to confirm your new selection. 2 pump spas have a combined **Up/Down** key. Hold the button to increase the parameter and release the button to stop. Hold the button again to decrease the parameter.

 The "Set Point" icon indicates that the display shows the desired temperature, NOT the current water temperature!

* If single speed pump: press Pump key to turn pump on. Press Pump key again to turn pump off.

OWNERS MANUAL - BEAR ESSENTIAL CLASS & CORE SERIES

Programming Steps



Program menu

The program menu is accessible by holding down the **Light** key for 5 seconds. In the program menu the following parameters can be set: clock, the filter or purge cycles, economy mode and temperature units. While you are in the program menu, use the **Up** or **Down** key to adjust the parameters and use the **Light** key to jump to the next parameter. The changes will be saved after the confirmation of

the last parameter only. If there is no action taken for 10 seconds, the system will exit the program menu without saving any changes.

Setting the clock

Enter the program menu by holding down the **Light** key for 5 seconds. The display will show the current clock setting with the hour flashing.

Depending on factory settings your system may be set to 24-hour time or 12-hour time.

Setting the hour: Use the **Up** or **Down** keys to adjust the hours. Press the **Light** key to jump to the next parameter, the minutes.

Setting the minutes: Use the **Up** or **Down** keys to adjust the minutes. Press the **Light** key to jump to the next parameter, the filter or purge start time (FS).

Programming the filter/purge cycles

Depending on system configuration your spa will perform either a filter or a purge cycle. The filter cycle menu consists of the following parameters: the start time (FS), the duration (Fd) and the frequency (FF). The purge cycle menu consists of the following parameters: the start time (FS) and the frequency (FF).

A filter cycle consists of starting all the pumps and blower in high speed for 1 minute (purge step) then, the pump associated with the filter will run in low speed for the remaining duration of the filter cycle (clean step).

A purge cycle is used when the spa is equipped with a 24 hour circulation pump which provides a continuous clean step. It consists of starting all the pumps and blower in high speed for 1 minute.



Setting filter or purge cycle start time

The display will show FSxx, "xx" representing the starting hour of the cycle. Use the **Up** or **Down** key to adjust the hours. Use the **Light** key to jump to the next parameter, filter duration (Fd).

Setting filter cycle duration

(not available on purge systems)
The display will show Fdxx, "xx" representing the duration in hours of the filter cycle. Use the **Up** or **Down** key to adjust the duration. Use the **Light** key to jump to the next parameter, filter or purge frequency (FF).

0 = no filtration
24 = continuous filtration

It is not recommended to set this to "0".

Setting filter or purge cycle frequency

The display will show FFxx, "xx" representing the number of cycles per day. Use the **Up** or **Down** key to adjust the frequency. Use the **Light** key to jump to the next parameter, economy mode (EP).

The "Filter cycle" indicator lights up when filter is on and flashes when suspended.

Setting economy mode

This mode allows you to lower the temperature set point of the spa by 20 °F (11 °C) during a certain period of the day.

The display will show EPx, "x" representing the state of the programmed economy (0 = disabled, 1 = enabled). Use the arrow keys to enable or disable economy mode. Use the **Light** key to jump to the next parameter, economy start time (ES).

Setting economy start time

The display will show ESxx, "xx" representing the hour at which the economy mode will become active. Use the **Up** or **Down** key to adjust the hour. Use the **Light** key to jump to the next parameter, economy duration (Ed).

When the Economy mode is ON, the display will toggle between the "Eco" message, the time, and the water temperature.

Setting economy duration

The display will show Edxx, "xx" representing the duration in hour of the economy mode. Use the **Up** or **Down** key to adjust the hour. Use the **Light** key to jump to the next parameter, temperature unit.

24 = continuous economy



Setting temperature unit

Water temperature can be displayed in either Fahrenheit (°F) or Celsius (°C). The display will show F or C.

Use the **Up** or **Down** key to change the setting. Use the **Light** key to save all the parameters.

Smart Winter Mode

Our Smart Winter Mode protects your system from the cold by turning pumps on several times a day to prevent water from freezing in pipes.

The "SWM" indicator lights up when freezing is detected and flashes when the purge is active.

Cooldown

After heating the spa water to the desired Set Point, the heater is turned off, but its associated pump (Pump 1 low-speed or CP) remains on for a predetermined period of time to ensure adequate cooling of the heating element, prolonging its useful life.

Water temperature regulation

Every 15 to 90 minutes the pump will run to ensure accurate water temperature readings as well as avoid heater activation in dry conditions. After verifying pump activation and taking a water temperature reading if required, the system automatically turns the heater on to reach and maintain water temperature at Set Point.

 Indicator flashes when taking water temperature reading.

Water temperature regulation

In a regulation cycle, the system first generates water flow through the heater housing and the plumbing, in order to ensure accurate water temperature readings as well as avoiding heater activation in dry conditions.

After verifying pump activation and taking a water temperature reading if required, the system automatically turns the heater on to reach and maintain water temperature at Set Point.

⏏ The “Heater” indicator lights up when the heater is on. It flashes when there is a request for more heat but the heater has not yet started.

Smart Winter Mode

Our Smart Winter Mode protects your system from the cold by turning pumps on several times a day to prevent water from freezing in pipes.

❄ The “Smart Winter Mode” indicator lights up when the Smart Winter Mode is on.

Cooldown

While performing this task, the heater is not allowed to turn on and its icon flashes.

Troubleshooting



Hr
An internal hardware error has been detected in in.xe. Contact dealer or service supplier.



HL
The system has shut the heater down because the temperature at the heater has reached 119°F (48°C). Do not enter the water! Remove the spa cover and allow the water to cool down, then shut power off and power your spa up again to reset the system.



AOH
Temperature inside the spa skirt is too high, causing the internal temperature in the in.xe to increase above normal limits. Open skirt and wait until error clears.



FLO
The system does not detect any water flow while the primary pump is running. Check and open water valves. Check for water level. Clean filter. If the problem persists, call your dealer or service supplier.

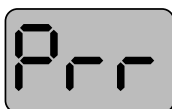

Prr
A problem is detected with the temperature probe. Call your dealer or service supplier.



OH
The water temperature in the spa has reached 108°F (42°C). Do not enter the water! Remove the spa cover and allow the water to cool down to a lower temperature. Call your dealer or service supplier if problem persists.

Hr error message / flow chart & step-by-step

 An internal hardware error has been detected

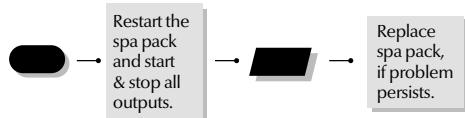

Step-by-Step

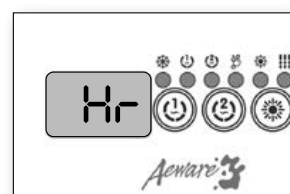

- Restart the spa pack and start & stop all pumps and blower.
- If error reappears, replace the spa pack.

Prr error message / flow chart & step-by-step

 Regulation probe issue

Flow chart

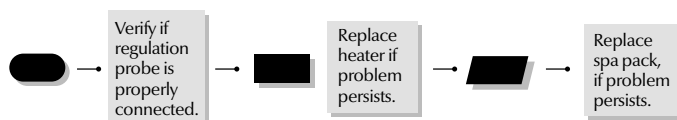

Step-by-Step

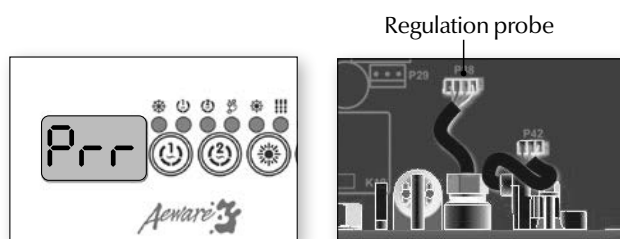

- Verify if regulation probe (located above the heater) is properly connected.
- Replace heater if problem persists.
- Replace spa pack, if problem persists.

HL error message / flow chart & step-by-step

HL The system has shut down because the temperature at the heater has reached 119°F (48°C).

Flow chart

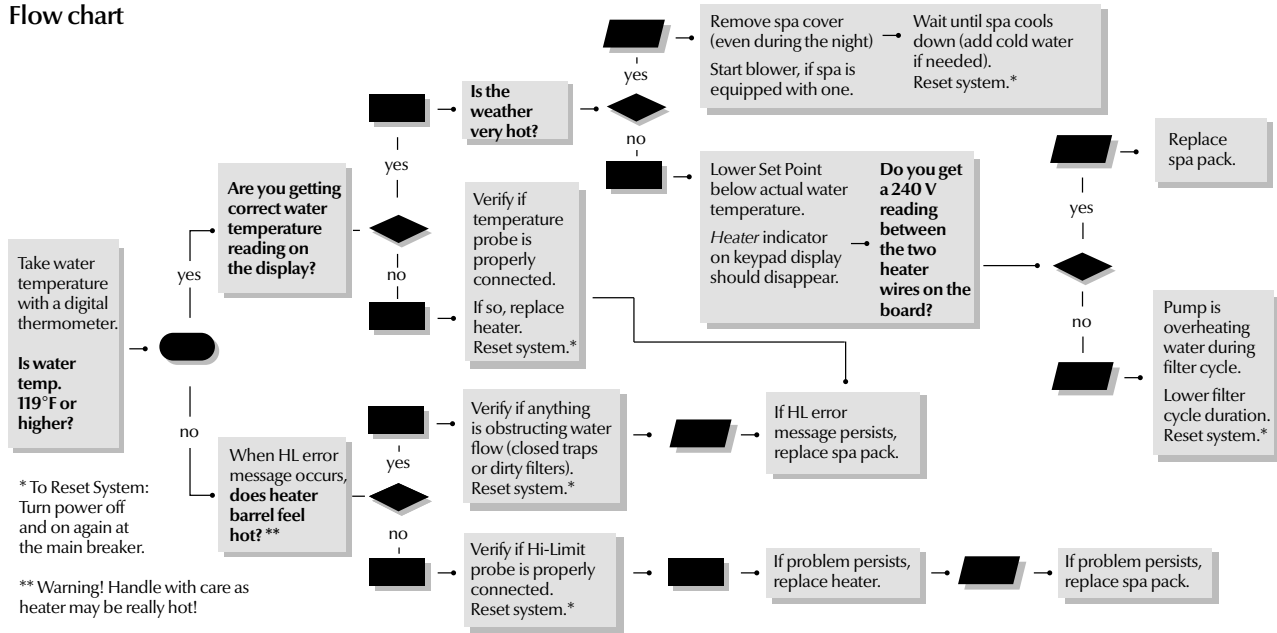

Step-by-Step

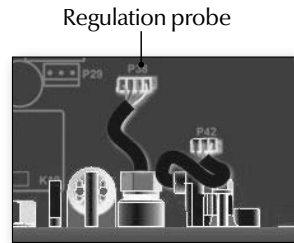
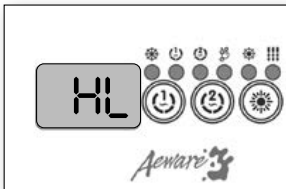

HL

Water temperature at the heater has reached 119°F

1. Measure the temperature with a DIGITAL thermometer and compare its reading with temp. on the display. Make sure the temp. reading is lower than 119°F.
 - Shut power off and power the spa up again to reset the system.
 - If HL error persists, replace heater.
 - If HL error persists, replace spa pack.
2. If reading is below 119°F:
 - Carefully check if heater barrel feels hot. If it's hot, verify if anything is obstructing water flow (closed valves or dirty filter).
 - Shut power off and power the spa up again to reset the system.
 - If HL error persists, replace heater.
 - If HL error persists, replace spa pack.
3. If reading is 119°F or higher:
 - Verify if the Temp. & High Limit probes are properly connected.
 - Shut power off and power the spa up again to reset the system.
 - If problem persists, replace heater.
 - If problem persists, replace spa pack.

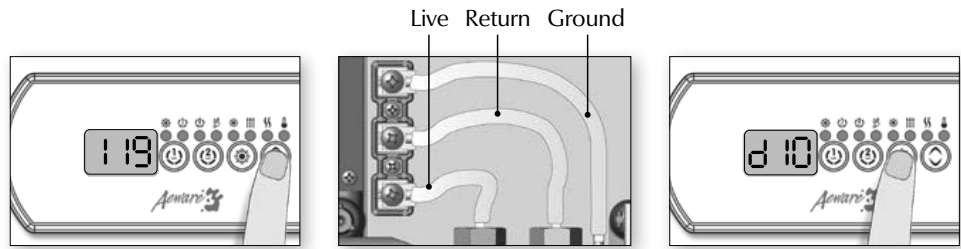

If weather is very hot:

1. Remove spa cover (even during the night). Start blower if spa is equipped with one. Wait until spa cools down (add cold water if necessary).

- Shut power off and power the spa up again to reset the system.

If hot weather is not a factor:

2. Lower Set Point below current water temperature.

The Heater indicator should disappear from keypad display.

3. With a voltmeter, read voltage between the live and ground heater terminals.

4. If you do read 240 V, replace spa pack.

5. If you do not read 240 V, pump may be overheating water during filter cycle.

Shorten filter cycle duration.

To shorten filter cycle duration:

6. Press and hold the **Light** key for 5 seconds. Display will show a value that represents the filter cycle duration in hours.

7. Use the **Down** arrow key to lower the number of hours.
0 = no filtration
12 = continuous filtration

When the desired setting is displayed, Press the **Light** key again. The filter cycle will start immediately.

FLO & UPL error message / flow chart & step-by-step



The system did not detect any water flow while the primary pump was running. Follow the troubleshooting flow chart below to identify the problem:

Make sure that the low-level programming has been properly set, with or without circulation pump (depending on your system configuration).

Flow chart

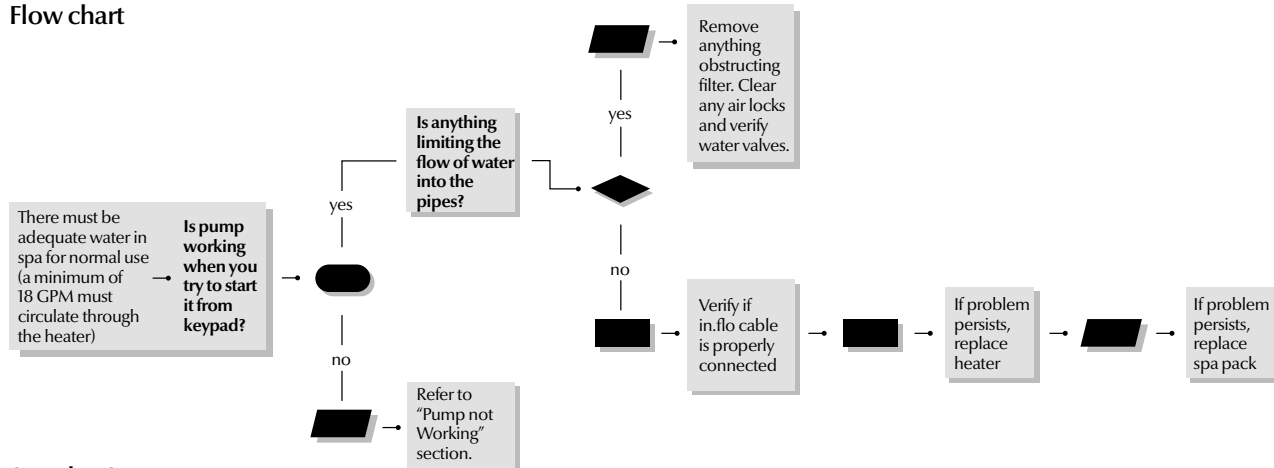

Step-by-Step

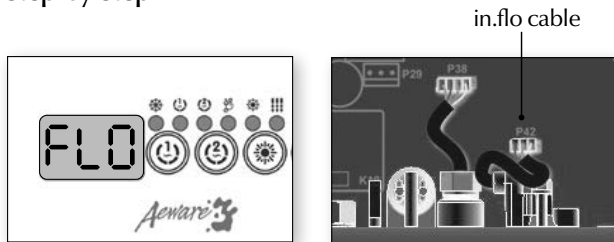

FLO Primary pump is activated, but the system doesn't detect any water flow

- Make sure water valves are open and that water level is high enough.
- Check and remove anything obstructing the filter.
- Make sure there is adequate flow and that no airlocks are trapped in the unit's plumbing. Pumps may make strange noises. If airlocks are formed, start the pump and slowly loosen one of the union nuts to release the air trapped in the plumbing. Tighten the nut again after you are done.
- Make sure that the pump associated to the heater (primary pump) is running.
- Make sure the in.flo cable (located above the heater) is properly connected.
- If problem persists replace heater.
- If the problem is not solved replace the spa pack.

OH error message / flow chart & step-by-step

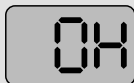

Water temp. in the spa has reached 108°F

Flow chart

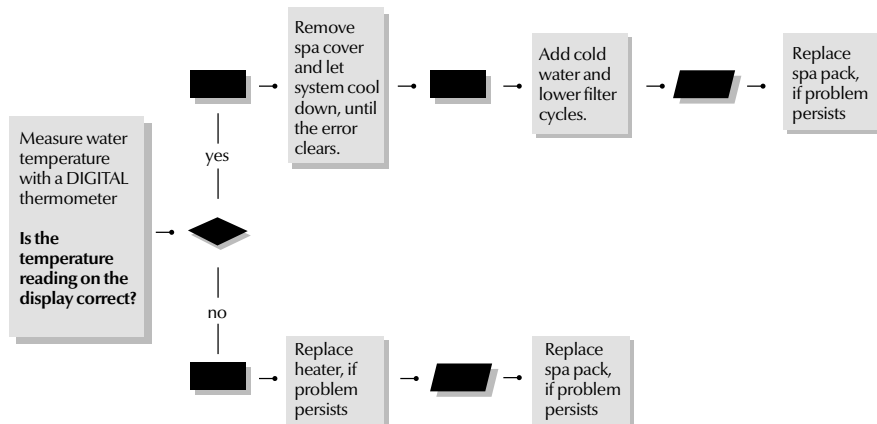

Step-by-Step



- Measure water temperature with a DIGITAL thermometer and compare its reading with temp. on the display. If temp. reading is different, replace heater.
- Remove spa cover and let spa cool down.
- Add cold water and lower filter cycles.
- If problem persists replace spa pack.

UPL error message / Step-by-Step



No low-level configuration software in system!

Step-by-Step



- New low-level configuration software needs to be downloaded into the spa system; without it the system will not be operable.
- Contact our toll free line for technical support (1-800-784-3256).

Note: this line is dedicated to assist authorized service technicians and dealers only.

Troubleshooting

Pump 1 doesn't work / flow chart & step-by-step

If Pump 1 is not working, follow this troubleshooting flow chart:

Flow chart

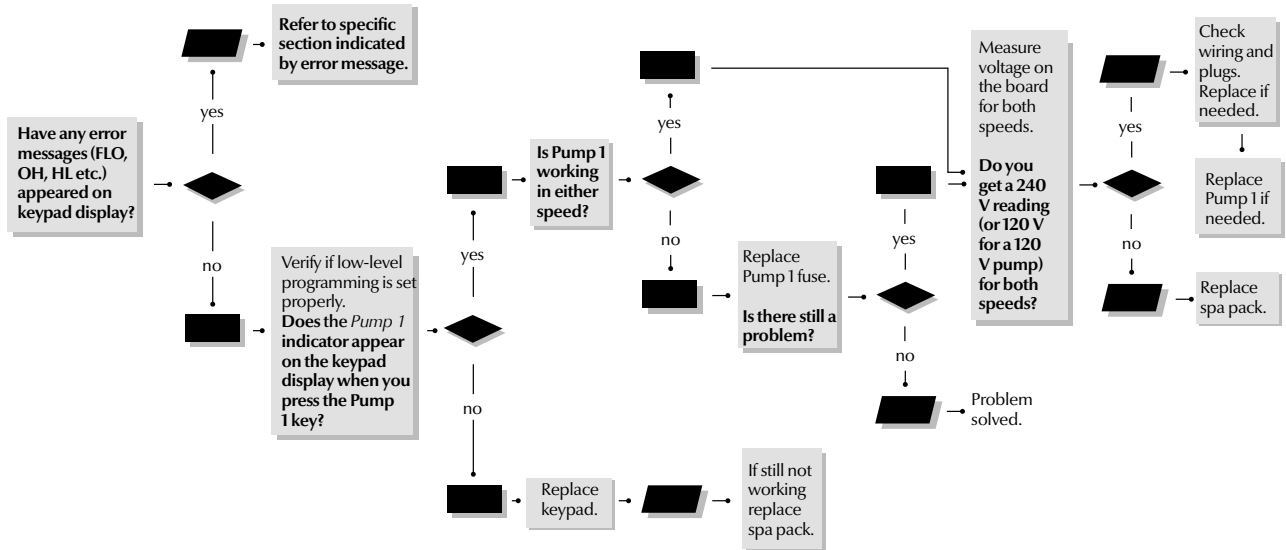

Step-by-Step

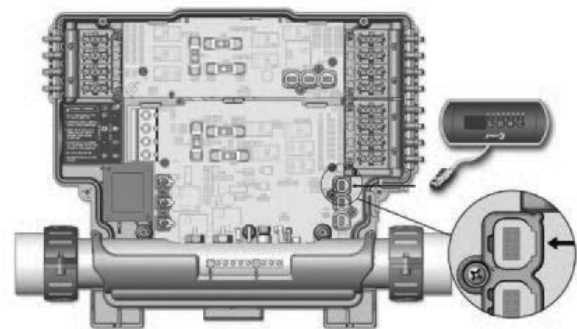
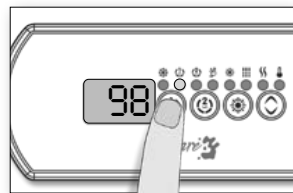

Pump 1 does not work!

- Check for an error message on keypad display. If there is one, refer to the specific section indicated by the error message.
- Verify low-level programming configuration.
- Verify if the Pump 1 indicator appears on keypad display when you press Key 1.
- If the Pump 1 indicator does not appear, use a spare keypad to verify if keypad is defective.
If it is, replace keypad.
If not, replace spa pack.
- If Pump 1 indicator appears when Key 1 is pressed, verify if pump works in either speed.

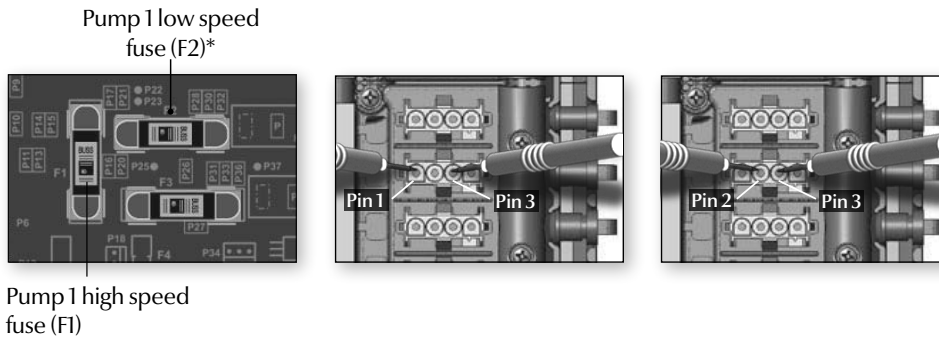

- If Pump 1 does not work in either speed, replace appropriate Pump 1 fuse.
- If replacing the fuse is not effective or if Pump 1 works in only one speed, take voltage reading on the corresponding in.link connector.

**Pump 1 high and low speed are F2 on the CE version.*

- Turn Pump 1 to high speed and take voltage reading between:
Pin 1 & Pin 3
Your reading should be:
240 V for a 240 V pump
120 V for a 120 V pump

- Turn Pump 1 to low speed and take voltage reading between:
Pin 2 & Pin 3
Your reading should be:
240 V for a 240 V pump
120 V for a 120 V pump

- If voltage is as it should be, replace Pump 1.
- If not, replace spa pack.

Pump 2 or blower doesn't work / flow chart & step-by-step

If Pump 2 or blower is not working, follow this troubleshooting flow chart:

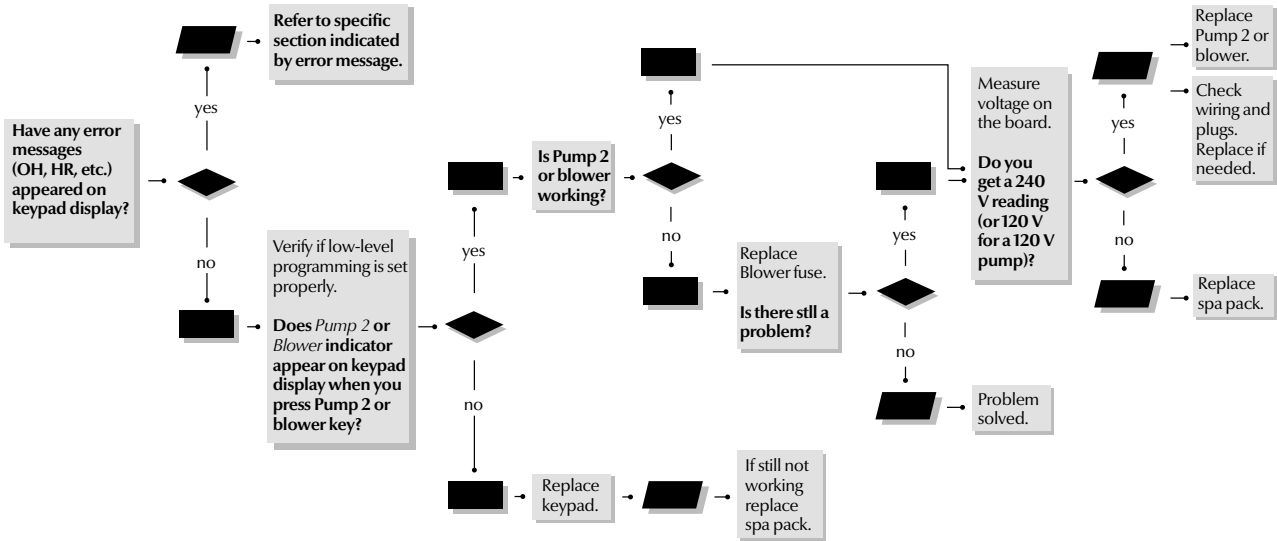

Step-by-Step

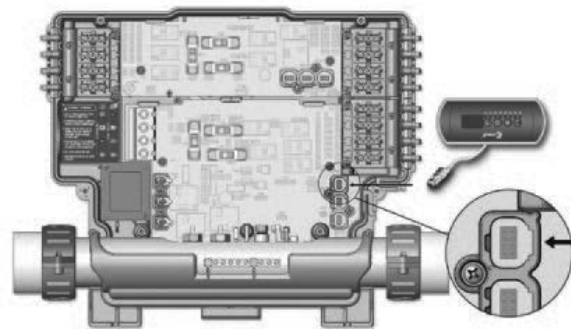
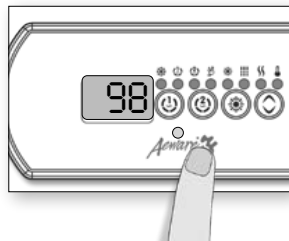

Pump 2 or blower is not working!

- Check for an error message on keypad display. If there is one, refer to the specific section indicated by the error message.
- Verify low-level programming configuration.
- Verify if Pump 2 or Blower indicator appears on keypad display when you press Key 2 button.
- If Pump 2 or Blower indicators do not appear, use a spare keypad to verify if keypad is defective. If it is, replace keypad. If not, replace spa pack.
- If Pump 2 indicator appears when Key 2 is pressed, verify if pump works in either speed (if dual speed pump).

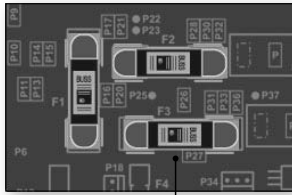

Pump 2 fuse (F3)

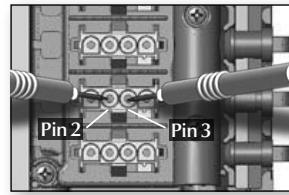
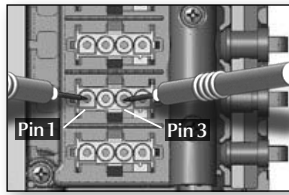

- If Pump 2 does not work in either speed, replace Pump 2 fuse.
- If replacing the fuse is not effective or if Pump 2 works in only one speed, take voltage reading on the corresponding AMP connector.

- Turn Pump 2 to high speed and take voltage reading between:

Pin 1 & Pin 3

Your reading should be:

240 V for a
240 V pump

120 V for a
120 V pump

- Turn Pump 2 to low speed and take voltage reading between:

Pin 2 & Pin 3

Your reading should be:

240 V for a
240 V pump

120 V for a
120 V pump

- If voltage is as it should be, replace Pump 2.
- If not, replace spa pack.

Ozonator doesn't work / flow chart & step-by-step

If the ozonator is not working, follow this troubleshooting flow chart:

Ozonator output will be shut down when Pump 1, Pump 2 or blower have been turned on manually.

Flow chart

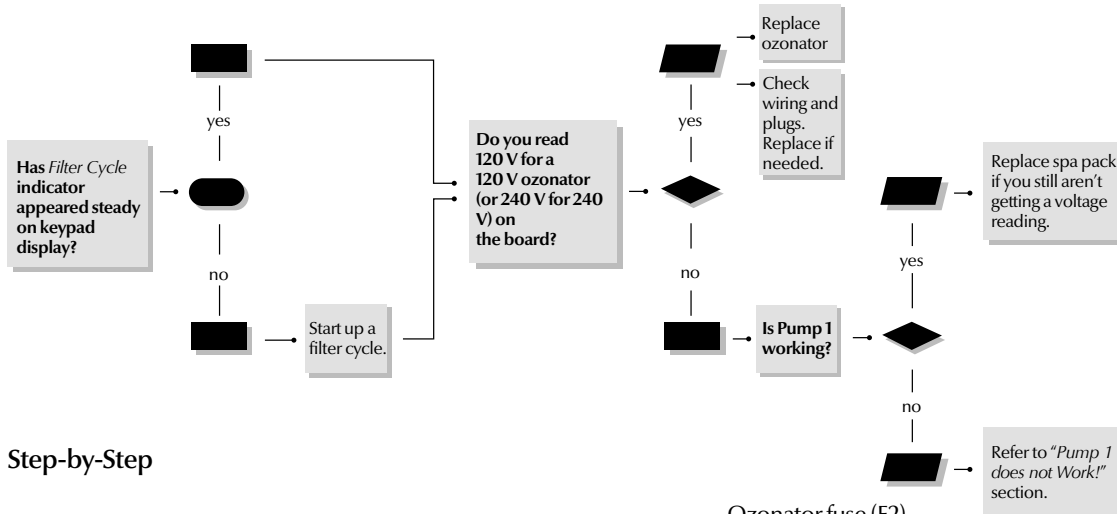

Step-by-Step

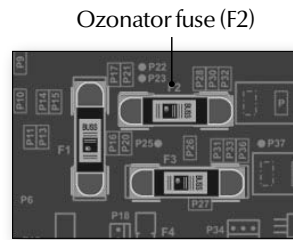
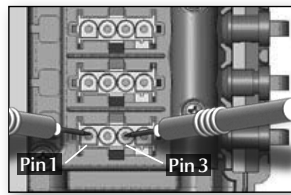
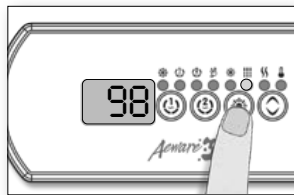

If the ozonator is not working:

- Check if Filter Cycle indicator appears steady on keypad.
- If the filter indicator is blinking it indicates that the filter cycle has been interrupted. In that case, reset the breaker by turning the power off and on again to resume cycle.
- If not, start up a filter cycle (see Programming Filter Cycles section).
- If ozonator does not work even when filter cycle indicator is on, take voltage reading on the corresponding AMP connector:
Pin 1 & Pin 3
Your reading should be:
240 V for a 240 V pump
120 V for a 120 V pump
- If you don't get a voltage reading, replace the accessory fuse.
- If changing the fuse does not fix the problem, replace the spa pack.
- If voltage is as it should be, replace ozonator.

Nothing seems to work / flow chart & step-by-step

If nothing seems to work, turn off the main breaker and visually inspect power input cable, gently pulling on it to make sure is properly tightened. Turn the main breaker back on and follow this troubleshooting flow chart:

Flow chart For North American systems

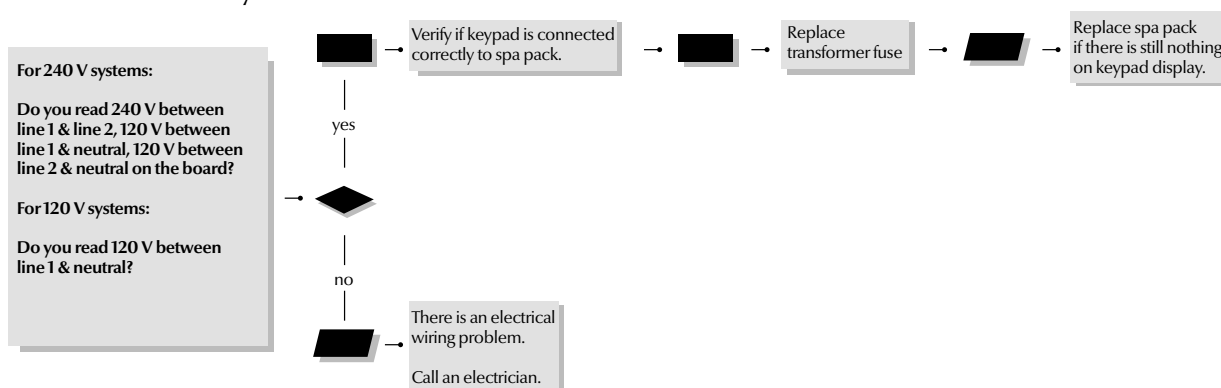

Step-by-Step for North American version

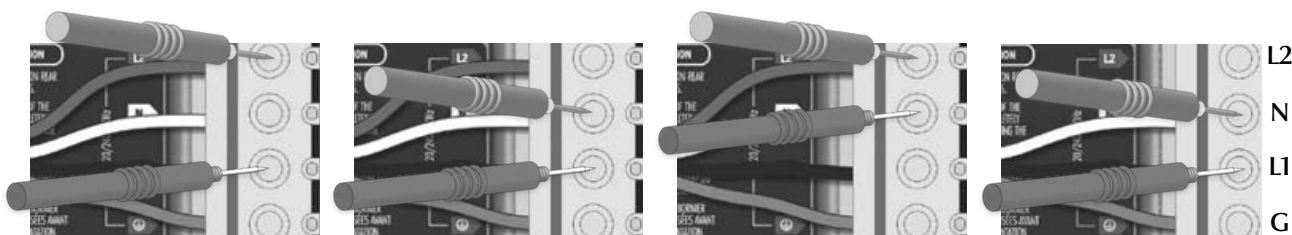

Nothing seems to work!

- Verify that all screws are properly tightened on the terminal block. Turn power off and make sure that all cables hold firmly in the terminal block if you pull on them. Once done, turn power back on.
- On the terminal block, measure voltage between line 1 and line 2.
- You should get 240 V.

- Measure voltage between line 1 and neutral.
- You should get 120 V.

- Measure voltage between line 2 and neutral.
- You should get 120 V.
- If you do not get good readings, this indicates an electrical wiring problem.

Call an electrician!

For 120 V systems

- Measure voltage between line 1 and neutral.
- You should get 120 V.
- If you do not get good readings, this indicates an electrical wiring problem.

Call an electrician!

Nothing seems to work (European version)/ flow chart

If nothing seems to work, turn off the main breaker and visually inspect power input cable, gently pulling on it to make sure is properly tightened. Turn the main breaker back on and follow this troubleshooting flow chart:

Flow chart For European systems

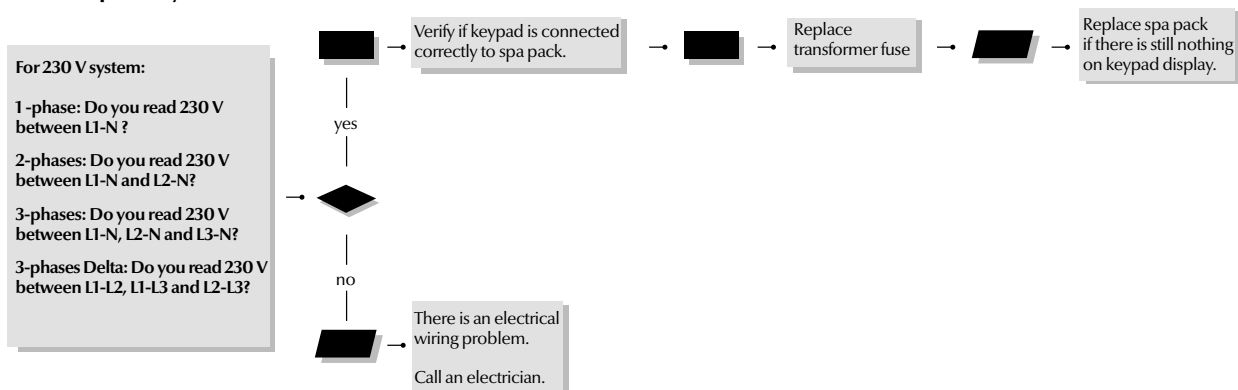

Step-by-Step

Nothing seems to work!

Verify that all screws are properly tightened on the terminal block. Turn power off and make sure that all cables hold firmly in the terminal block if you pull on them. Once done, turn power back on.

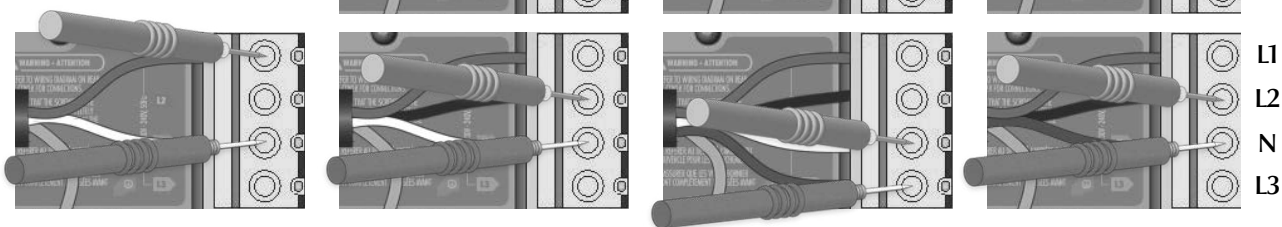

For 1-phase system

- On the terminal block, measure voltage between line 1 and neutral.
- You should get 230 V.
- If you do not get good readings, this indicates an electrical wiring problem.
Call an electrician!

For 2-phase system

- Measure voltage between line 1 and neutral and between line 2 and neutral.
- You should get 230 V on both readings.
- If you do not get good readings, this indicates an electrical wiring problem.
Call an electrician!

For 3-phase system

- Measure voltage between line 1 and neutral, between line 2 and neutral and between line 3 and neutral.
- You should get 230 V for each reading.
- If you do not get good readings, this indicates an electrical wiring problem.
Call an electrician!

For 3-phase Delta system

- Measure voltage between line 1 and line 2, between line 1 and line 3 and between line 2 and line 3.
- You should get 230 V for each reading.
- If you do not get good readings, this indicates an electrical wiring problem.
Call an electrician!

If the voltage reading are OK then:

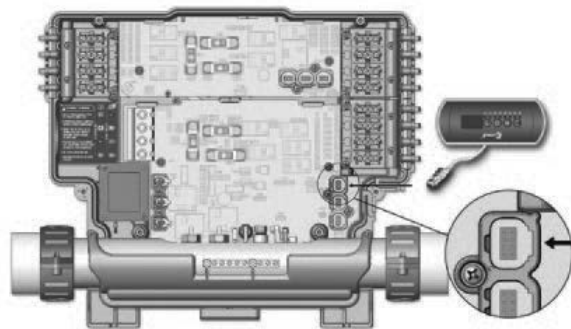

- Verify if keypad is correctly connected to the spa pack.

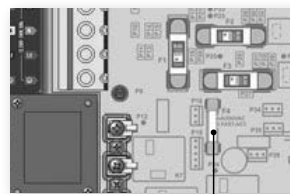

Transformer fuse

- Verify the transformer fuse.
- Replace transformer fuse if necessary.
- If problem persists, replace spa pack.

Spa not heating / flow chart & step-by-step

If spa is not heating, follow this troubleshooting flow chart:

Flow chart

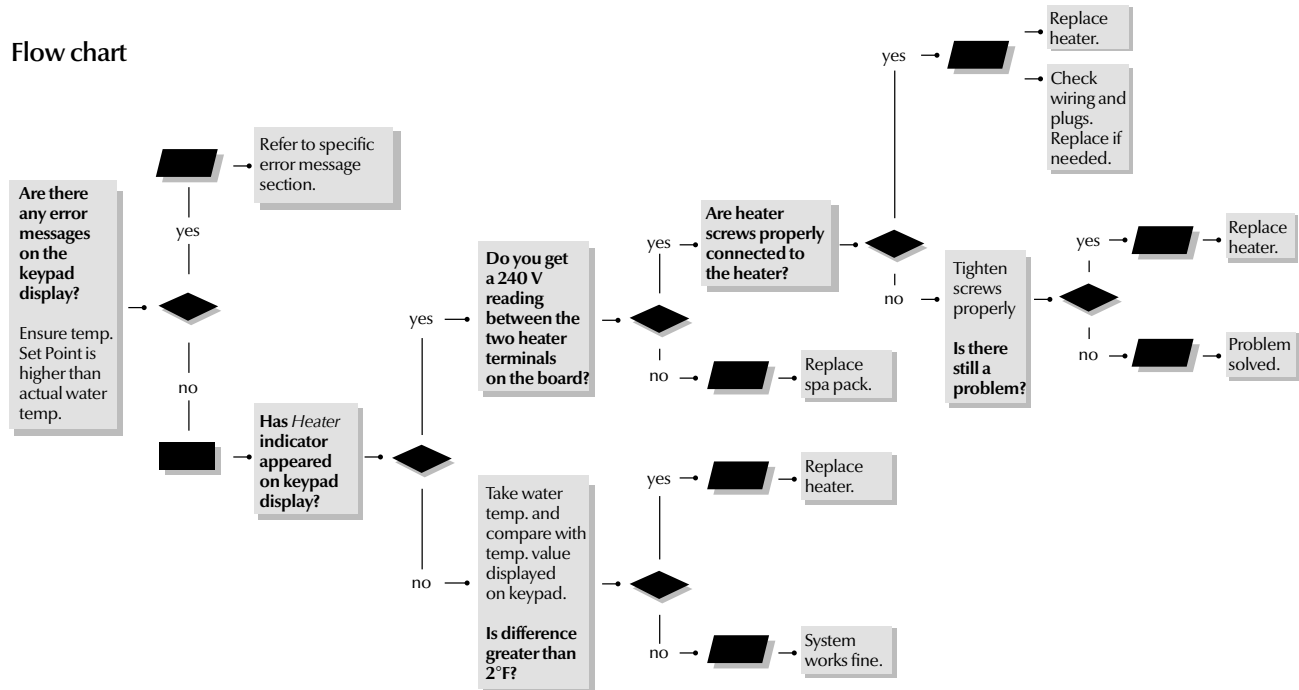

Set Point indicator

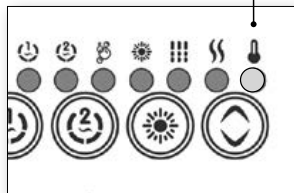

Heater indicator

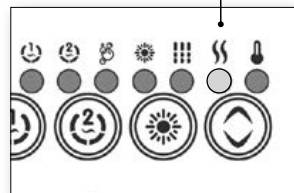

Live Return Ground

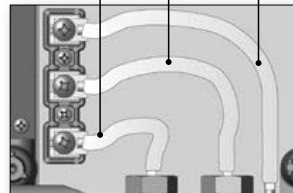

Heater fuse (F1)
(CE Model only)

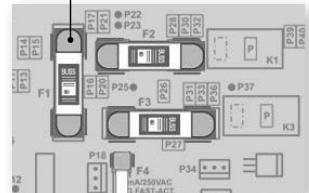

Spa not heating!

- Check for an error message on keypad display. If there is one, refer to specific section indicated by the error message.
- If there is no error message, try to raise water temperature by increasing the Set Point 2°F higher than actual water temperature. Press Up key to increase Set Point.
- Verify if Heater indicator appears on keypad display.
- The heater indicator will be on when heater is on. It will flash if more heat has been requested, but heater has not started yet.
- If heater indicator lights up on the display, take voltage reading between the heater live and return terminals.
Your reading should be:
240 V: for 240 V heaters
120 V: for 120 V heaters
- If voltage reading is not as it should be, verify if heater terminals are properly connected .
- If it is, replace spa pack.
- In the case of the European model in.yt.ce only, replace accessory fuse.
- If problem persists, replace spa pack.

Keypad doesn't seem to work step-by-step

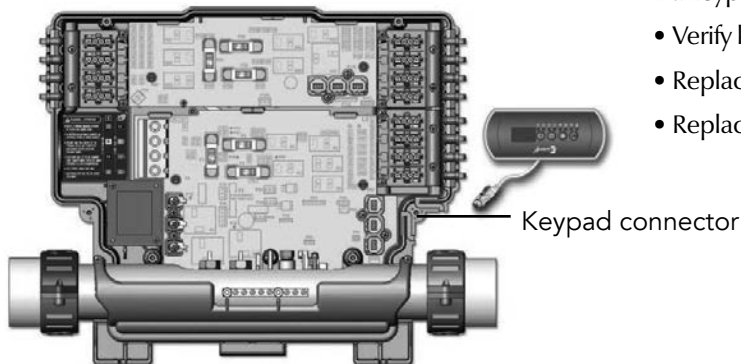

If a keypad doesn't work:

- Verify keypad connections and try spare keypad.
- Replace keypad if problem is corrected.
- Replace pack if problem is not corrected.

GFCI trips

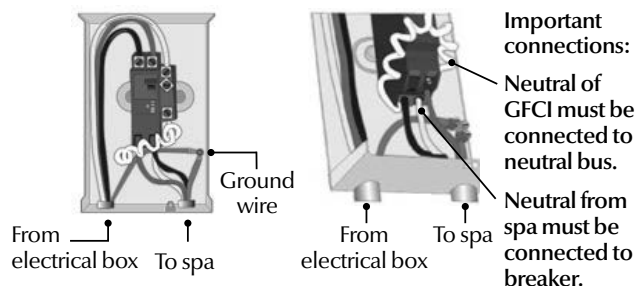
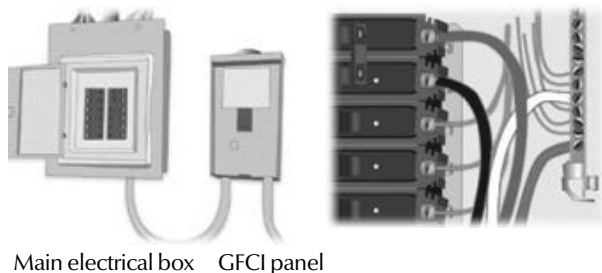

⚠ Warning!

Total current output cannot exceed total current input rating!

There are different GFCI models used on the market. See manufacturer's instructions that come with the GFCI for specific information. Note that all illustrations are examples only.

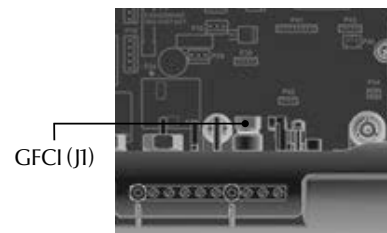

The Y Series packs are equipped with a GFCI tripper circuit in case an HL error occurs.

- Find the GFCI tripper circuit (JI) on the board located behind the temperature probe and remove the jumper.
- Activate the GFCI and see if an error occurs. If HL appears, follow the HL error troubleshooting chart (in the Troubleshooting section).
- If no error occurs, re-install the jumper.
If the GFCI trips again replace the pack.
- If the GFCI is still tripping, the error doesn't come from the GFCI tripper circuit.
- Verify that the GFCI circuit is properly connected.

- If it's not, reconnect it.
- Verify the spa pack wiring (make sure that the neutral and the ground have not been inverted)

If the GFCI is properly connected but still tripping,

- Unplug all outputs from the spa pack (pumps, blower, heater, ozonator etc).
- If it doesn't trip while all outputs are unplugged, reconnect one output at a time until the GFCI trips again.
- Replace defective component.

Note: Incorrect GFCI wiring may lead to a condition where the GFCI may NOT trip when it should, causing electrical shock hazard. All electrical installations should be done by qualified personnel only.

OWNERS MANUAL - BEAR ESSENTIAL CLASS & CORE SERIES

How to Set the Clock, Filtration and Essentials Salt

NOTE: Essential Salt is NOT available in CORE Series



Press and hold the light key for 5-10 seconds



Let go of the light button when the hour starts flashing on the time



Set the hour by using the up/down arrows/ Press the light button to set the minutes same way as the hours



Once the time is set press the light key to set filtration



FS will show up that is your filtration start time. Set the start time to whenever you want the filtration to start by using the up/down arrows. Then press the light key to set Filter Duration



Fd will show up. Set the duration that you want by using the up/down arrows then press the light key to set Filter Frequency

OWNERS MANUAL - BEAR ESSENTIAL CLASS & CORE SERIES

How to Set the Clock, Filtration and Essentials Salt

NOTE: Essential Salt is NOT available in CORE Series



FF will show up. Press the up/down arrows to set the Filter Frequency that you want. Press the light key to continue to set Essentials Salt



OS will show up. This is the Salt start time. Use the up/down arrows to set the time you want Essentials Salt to start. Press the light button to continue



Od will show up. This is the duration you want the salt system to run. Set the duration that you want by using the up/down arrows then press the light key to continue



oF will show up this is the Frequency you want the salt to run. Set the Frequency that you want by using the up/down arrows then press the light key to continue



Temperature setting will show up choose between Celsius and Fahrenheit by using the up/down key. Press the light button to exit the settings



Once you exit the settings the clock will appear and the settings will be saved

OWNERS MANUAL - BEAR ESSENTIAL CLASS & CORE SERIES

How to Set Low Level Programming on INYE Pack

NOTE: Essential Salt is NOT available in CORE Series



To access Low Level programming hold down Pump 1 button for 25-30 seconds



Let go of the Pump 1 button when LL and a number shows up



To adjust the Low Level setting press and hold the up/down arrows until you get the setting you want



Once you found the Low Level setting that press the light key to save the setting



The Pack will reset and the setting will be saved

INYE 3 Low Level Settings

- LL 1 – One pump
- LL 2 – Two pumps
- LL 3 – One pump w/eco mode
- LL 4 – Two pumps w/eco mode
- LL 5 – One pump w/salt
- LL 6 – One pump w/salt w/ eco mode

INYE 5 Low Level Settings

- LL 1 – Two pumps w/salt
- LL 2 – Two pumps w/salt w/eco mode

OWNERS MANUAL - BEAR ESSENTIAL CLASS & CORE SERIES

Specifications

Environmental ratings:

Operating temperature:	32°F (0°C) to 136°F (58°C)
Storage temperature:	-13°F (-25°C) to 185°F (85°C)
Humidity:	Up to 85% RH, non condensing
IPx5 level of waterproofing	

Mechanical:

in.ye

Weight:	Up to 9.7 lbs (4.4 kg)
Dimensions (W x H x D):	19.598" x 10.75" x 4.98" (497 x 273 x 126 mm)

in.yt

Weight:	Up to 12 lbs (4.45 kg)
Dimensions (W x H x D):	19.58" x 14.5" x 5.1" (497 x 368 x 130 mm)

Model Y Series UL/CSA electrical specifications

Input rating:	120/240 V nominal (+5/-10%) (2 lines required with neutral) 48 A Max,
or (in.ye-3 only):	120 V nominal only (+5/-10%) (single line with neutral) 16 A Max, 60 Hz nominal (+1.5 / -1.0 Hz)

Heat.wav rating:

Voltage:	120 or 240 V, 60Hz
Wattage:	4 kW at 240 V, 1 kW at 120 V (Also available: 5.5 kW at 240 V)
Flow rate:	Minimum of 18 GPM (68 LPM) is required

UL 1563 Sixth Ed.

UL File: E182156

CSA No. 22.2 - 218.1-M89.



Model Y Series TUV electrical specifications

Input rating:	230/240 V nominal (+5/-10%) (2-phase system with neutral) 20 A Max per phase, (3-phase system with neutral) 16A Max per phase.
or (in.ye-3 only):	240 V nominal only (+5/-10%) (single-phase system with neutral) 48 A Max, 50 Hz nominal (+1.5 / -1.0 Hz)

Heat.wav rating:

Voltage:	240 V, 50Hz
Wattage:	3.8 kW at 230 V 2.8 kW at 230 V
Flow rate:	Minimum of 18 GPM (68 LPM) is required

EN/IEC 60335 - 2 - 60/A2: 2008 - EN/IEC 60335 - 1: 2010

EN55014-1

EN55014-2

EN61000-3-2

EN61000-3-3



OWNERS MANUAL - BEAR ESSENTIAL CLASS & CORE SERIES

North American Models

Device	Voltage	Maximum current	ye-3*1
Pump 1 (2-spd)	120 or 240 V	15 FLA/60 LRA (inrush)	●
Pump 2 (2-spd)	120 or 240 V	15 FLA/60 LRA (inrush)	●*2
Pump 3 (2-spd)	120 or 240 V	15 FLA/60 LRA (inrush)	
Pump 4 (2-spd)	120 or 240 V	15 FLA/60 LRA (inrush)	
Pump 5 (1-spd)	120 or 240 V	15 FLA/60 LRA (inrush)	
O3/CP	120 or 240 V	6 FLA/10 A	●*3
AI	120 or 240 V	15 FLA/60 LRA (inrush)	
Blower	120 or 240 V	15 FLA/60 LRA (inrush)	
CP	120 or 240 V	6 FLA/10 A	
O3	120 or 240 V	6 FLA/10 A	
Direct out 1	120 or 240 V	10 A (always on)	
Direct out 2	120 or 240 V	10 A (always on)	

*1 This model can be converted to a dedicated 120 V model.

*2 Pump #2 can only be installed if Pump #1 is a single-speed pump.

*3 Total of Pump #1-low (or Pumps #2) and O3/ CP cannot exceed 15 FLA.

*7 If CP is used, Pump 3 must be 1-speed
Total of pump 1-low, O3 and Di1 must not exceed 15 FLA
Total of P3, CP, and Di2 must not exceed 15 FLA

*8 If AI is used, Pump 4 must be 1-speed
Total of O3 and Di1 must not exceed 15 FLA
Total of P3, CP, and Di2 must not exceed 15 FLA
Total of P5, and B must not exceed 15 FLA
Total of P4, and AI must not exceed 20 FLA

European Models

Device	Voltage	Maximum current	ye-3*
Pump 1 (2-spd)	230 V	15 FLA/60 LRA (inrush)	●
Pump 2 (2-spd)	230 V	15 FLA/60 LRA (inrush)	●*1
Pump 3 (2-spd)	230 V	15 FLA/60 LRA (inrush)	
Pump 4 (2-spd)	230 V	15 FLA/60 LRA (inrush)	
Pump 5 (1-spd)	230 V	15 FLA/60 LRA (inrush)	
O3/CP	230 V	6 FLA/10 A	●*2
AI	230 V	15 FLA/60 LRA (inrush)	
Blower	230 V	15 FLA/60 LRA (inrush)	
CP	230 V	6 FLA/10 A	
O3	230 V	6 FLA/10 A	
Direct out 1	230 V	10 A (always on)	
Direct out 2	230 V	10 A (always on)	

*1 Pump #2 can only be installed if Pump #1 is a single-speed pump.

*2 Total of Pump #1-low (or Pumps #2) and O3/ CP cannot exceed 20 FLA.

AquaNova® (only available in CORE Series)

IMPORTANT SAFETY INSTRUCTIONS

Appliance contains a UV-C emitter.

WARNING: UV emitted from this lamp. Skin or eye injury could result. Avoid exposure of eyes and skin to unshielded lamp

WARNING: Do not operate the UV-C emitter when it is removed from the appliance enclosure.

Precautions to be taken when replacing UV-C emitters.

Unintended use of the appliance or damage to the housing may result in the escape of dangerous UV-C radiation. UV-C radiation may, even in little doses cause harm to the eyes and skin.

Appliances that are obviously damaged must not be operated.



CAUTION: Risk of Personal Injury!

- **DANGER ULTRAVIOLET RADIATION.** The appliance must be disconnected from the supply before replacing the UV-C emitter.
- **WARNING:** Disconnect the appliance from the supply before carrying out maintenance.
- **Warning:** UV emitted from this lamp. Skin or eye injury could result. Avoid exposure of eyes and skin to unshielded lamp.
- **NEVER** look at the UV lamp when powered on.
- **NEVER** breathe in or ingest the nitric acid crystals for any reason. Crystals from nitric acid can accumulate in the air lines of the spa ozonator. Wear protective gear when working on the ozonator. Nitric acid will cause chemical burns on skin, if unprotected.
- **NEVER** blow into the spa ozonator or connected plumbing for any reason.
- **NEVER** inhale concentrated ozone gas produced by this device for any reason because it can cause serious harmful effects.
- **NEVER** place tubing connected to this device in your mouth for any reason.



SAFETY: Product Safety Agency Ratings

This spa sanitizer has been tested and designed for safety and given the UL Certification. If properly installed, ozone performs its oxidizing function and separates before off gassing.

Note: As with all alternate sanitizing systems, it will not replace the chlorine residual you need to retain in your system to ensure the health of your swimmers.

This product must be installed underneath the spa in the equipment compartment with extra care to ensure it is not exposed after installation.

Specifications

- Ozone output: 80mg/hr.
- UV-C Lamp: 254 Nanometers
- Power input:
 - > North America: 120V 60Hz or 240V 50/60Hz
 - > Europe: 230V 50/60Hz
- Dimensions: 13.8" (350mm) x 6.3" (160mm) x 3.4" (85mm)
- Weight: 3.3 lbs (1.5kg).
- Air inlet: Filtered Ambient Air
- LED indicator to signal Ozone and UV operating normally (green)
- LED indicator to signal UV-C Lamp replacement (flashing yellow)
- LED indicator to signal non-operational (red)
- IF indicators are either flashing yellow or red, contact your dealer for service



Features

- UL / TUV / SAA Certified
- Water resistant to IPX5
- Ozone/UV-resistant components
- Compact design and quiet operation

General Product Information

The AquaNova® Spa Sanitizing system is designed for use with portable spas and be controlled by the spa's equipment pack. Any application outside of this may void the warranty.

This system combines the benefits of both Ozone and UV-C sanitization utilizing a patented UV Chamber to both inject ozone into the water, mix it and then expose it to powerful UV-C rays, all-in-one. This process not only kills and deactivates microorganisms in the water as it passes, but also creates a powerful hydroxyl radical to burn off contaminants and dissolved solids within the water to significantly increase the clarity of the spa water. The UV-C rays also breakdown chloramines which are the main cause of respiratory, eye, and skin irritation typically associated with chlorine. Harmful/corrosive off-gassing is also dramatically reduced through this process.

Power & No Flow Protection:

The AquaNova™ Spa Sanitizer has no built-in flow protection. It relies solely on the spa control pack to provide electrical power and flow protection. When the spa pump low comes on AquaNova™ Spa Sanitizer will come on. When the pump turns off, the AquaNova™ Spa Sanitizer will turn off.

Operation

To achieve optimal performance from the AquaNova® Spa Sanitizer start with a clean spa.

- 1.- Super chlorinate spa water using chlorine based shock treatment.
- 2.- Test spa chemistry and adjust pH between 7.4 and 7.6. Adjust total alkalinity between 80ppm and 120ppm.
- 3.- Set the filtration cycle frequency and duration to best suit your particular spa as per the spa manufacturer's recommendations. Longer filtration cycles may be required if the plumbing by-pass method has been used to plumb the spa.
- 4.- While operating, check regularly to see if bubbles are entering the spa.
- 5.- A supplementary sanitizer will be required to use in conjunction with the AquaNova® Spa Sanitizer.

Ordering Information

Call your local Dealer for ordering assistance. Please have the following with you when calling for assistance.

- 1.- Contact information
- 2.- Shipping address
- 3.- Credit card for payment

If you experience complications, contact us on arctichottubsparts.com

NOTE: AQUANOVA is NOT available in Bear Essentials Class

In.Touch 2 Internet Control available in CORE series
Please refer to the TechBook enclosed



Bear Essential Class Spas Warranty

Spa Shell ~ 7 years

Arctic Spas® warrants the spa shell to the customer against water loss due to structural failure for a period of 7 years.

Equipment & Plumbing ~ 3 year parts and 1 year labour

Arctic Spas® warrants the spa's electrical equipment components ~ specifically the pump(s) *(please refer to detailed pump warranty below), factory installed ozone system, heater (including the Tru-Guard™ Heater) and control system against malfunctions due to defects in materials and workmanship for a period of 3 years to the original purchaser from the original date of delivery. Includes parts necessary to repair. Labour is included for a period of 1 year.

Other Components ~ 3 years

Arctic Spas® warrants the fuses, lights, jet inserts, topside control overlays, cabinet material, filter baskets and weir assemblies, diverter handles and caps, air control handles and caps, plastic cover clips, chrome trim and all other unmentioned components to be free of defects in workmanship and materials for a period of 3 years to the original purchaser from the original date of delivery. Includes only parts necessary to repair, not labour.

Shell Surface ~ 3 years

Arctic Spas® warrants the interior surface to the customer against water loss due to material failure including cracks, blisters, peeling and delaminating for a period of 3 years to the original purchaser from the original date of delivery. Includes parts and labour necessary to repair.

Standard Cover ~ 1 year

Arctic Spas® warrants the standard Bear Essentials cover against malfunctions due to defects in materials and workmanship for one year to the original owner from the original date of delivery. Includes parts necessary to repair.

Upgraded Mylovac Cover ~ 3 years

Arctic Spas® warrants the upgraded MYLOVAC™ cover against malfunctions due to defects in materials and workmanship for three years to the original owner from the original date of delivery. Includes parts necessary to repair. (Normal wear and tear is not included in this warranty, when used with a cover lifter seam damage will be considered normal wear and tear.

Essential Sound ~ 1 year

Arctic Spas® warrants the factory installed essential sound stereo system against malfunction due to defects in materials and workmanship for one year to the original customer from original customer from original delivery. Includes parts and onsite labour necessary to repair.

Essential Salt ~ 2 year Parts - 1 year labor

Arctic Spas® warrants the factory installed essential salt system against malfunction due to defects in materials and workmanship for two year labor to the original customer from original customer from original delivery.

Forever Floor ~ 3 years

Arctic Spas® warrants the Forever Floor against rotting and structure cracking for a period of 3 years to the original customer from the original date of delivery. Includes parts and onsite labour necessary to repair.

Arctic Spas® extends this limited warranty solely to the original customer of any Arctic self-contained spa installed by an approved Arctic Spas Dealer, for 3 years of delivery date or 4 years from manufacture ship original purchaser of the spa.

DETAILED PUMP WARRANTY

Pump(s) are warranted against material and component failure. The pump shaft seal is covered under warranty. Damage resulting from a neglected leaking shaft seal is not covered under warranty. This includes but is not limited to bearing seizure, end bell failure, start switch failure, impeller failure and capacitor failure. It is the responsibility of the customer to report shaft seal failure before further damage can occur. Any pump component failure determined to be the result of defective material will be replaced under warranty. Arctic Spas® reserves the right to replace pump components, rather than the complete pump assembly. Vibration noise associated with normal pump operation is excluded under this warranty.

PERFORMANCE

To obtain service in the event of a defect or malfunction covered by this Limited Warranty, notify your Arctic Spa dealer as soon as possible and use all reasonable means to protect the spa from further damage. Upon proof of purchase, Arctic Spas® agent or its designated service representative will correct the defect subject to the terms and conditions continued in this Limited Warranty. Pre-Approved claims must be executed within 60 days of Pre-approval, All existing claims expire upon expiration of warranty. *Please note that union connection leaks are considered to be user serviceable and are expressly excluded from the Limited Warranty. Damage resulting from union connection leaks are expressly excluded from the Limited Warranty. There will be no charge for on site labour to the customer for a period of one year from the date of original delivery or 2 years from manufacturer's ship date, whichever comes first. Specifically equipment, plumbing and shell surfaces against malfunctions due to any defect in the material and workmanship within the Limited Warranty. Travel costs are the responsibility of the customer. Your limited warranty will cover a maximum of \$60 towards on site labor per each approved warranty claim. Service and/or travel costs are covered within the first 30 days of ownership to a maximum distance of 100KM from dealership or designated service outlet. If Arctic Spas® determines that repair of the covered defect is not feasible we reserve the right to instead provide a replacement spa equal in value to the original purchase price of the defective spa. Spa replacement is done only at the discretion of Arctic Spas®. Reasonable costs for the removal of the defective spa, and delivery and installation will be the responsibility of the spa customer. Freight will be paid to the nearest Arctic Spas® distribution centre.

CONDITIONS OF WARRANTIES

All warranties provided hereunder extend only to the original customer of the spa if purchased by an authorized Arctic Spas dealer and originally installed within the boundaries of the country where it was originally purchased. All warranties hereunder terminate upon transfer of ownership of a spa from the original customer. This warranty only applies within the service area where the spa was originally installed. Your limited warranty does not include repair travel mileage or for shipping cost assessed by your Factory Authorized Dealer or service agents. All events covered by this Limited Warranty hereunder must be repaired by a Factory Authorized Dealer of Arctic Spas®. The warranties will not include any costs of repair incurred by a non-factory authorized agent. To obtain service, the customer must contact the Factory Authorized Dealer in his area. In the event that a spa or component thereof must be returned to Arctic Spas® distribution centre, all freight costs are the responsibility of the spa customer. In all cases Arctic Spas® has sole responsibility for determining the cause and nature of failure of the spa and Arctic Spas® determination with regard thereto shall be final.



Bear Essential Class Warranty (continued)

EXCLUSIONS

All warranties hereunder are void if the spa has been subject to alterations (including after-market accessories), misuse or abuse or any repair of the spa has been attempted by anyone other than a Factory Authorized Dealer of Arctic Spas®. Alterations include but not limited to, any change to the components, replacement of components or addition of components without the written authorization from Arctic Spas®. Misuse includes careless handling of the spa, damages caused by improper and/or non-certified electrical hook-ups, failure to operate the spa in accordance with the instructions contained in the owner's manual provided with the spa, including incorrect start-up procedures or dry firing of the spa, any use of the spa or any of its components in an application for which it was not designed, and damage caused by improper chemical balance (including any damage to spa components caused by scale build up to due to poor water chemistry), ice in the spa, overheating the spa or spa water, damage to the spa surface by allowing undissolved sanitizing chemicals to lie on the surface or if our spa has been used for commercial purposes. Spa covers are not warranted against chemical burn or discolouration. Spa covers are not warranted against water absorption or any damage resulting from water absorption. Any damage resulting from the mishandling of the spa cover in any way is not covered under warranty. Any damage caused by moving of the spa or improper installation (including insufficiently prepared or uneven ground) is considered abuse and any damage to the material or workmanship of the spa cabinetry and floor in shipping or handling are expressly excluded from the Limited Warranty.

Arctic Spas will not be responsible for power company issues or improper electrical installations, Damage and/or lack of performance resulting from high or low voltages outside operating parameters. Arctic Spas will not be responsible for software and product upgrades throughout the life of the spa.

Arctic Spas® expressly excludes warranty coverage on any of the following: Acts of nature including but not limited to damage resulting from lightning, storm, flooding, freezing, fire and any other acts of nature. Any spa installed in a commercial application. Any failure caused by improper cover use or damage to the spa surface by leaving the spa outdoors without the hot tub cover in place. The heat created by leaving the spa in direct UV light without a cover may cause surface issues with the acrylic and may also cause plastic parts to warp, some fittings will leak or cease working as a result. These occurrences are not covered under warranty. The hot tub cover must be kept on the hot tub when not being used.

Scratches or micro-crazing in the spa shell reported after the day of installation are not covered under warranty. Micro-crazing is defined as an area of tiny shiny lines visible in areas on the surface of some thermoplastic sheets. This phenomena, although rare, is known to occur in many types of plastic sheet materials. The surfaces of thermoformed acrylic hot tubs are not immune to this possibility.

Damaged caused by unapproved sanitizers such as tri-chlor, acids, calcium hypochlorite, sodium hypochlorite, peroxides, any sanitizing chemical that may remain undissolved on the spa surface. **Any and all sanitation systems or chemicals used in your spa must be factory approved by Arctic Spas or your**

warranty is void. You can check for a list of approved systems and chemicals at arcticspas.com. Installation of not factory approved salt systems will void the warranty related to pump seals, metal part, jets, etc. Damage caused by any item(s) attached to or installed onto the spa, including but not limited to gazebos, cover lifters and cedar accessories. Any options or additional components that are not factory installed are not covered under warranty. Any damage or failure due to improper preparation for winter storage is not covered under warranty. Damage to pillows reported beyond the day of delivery will not be covered under warranty. Pillows are to be removed from the spa when not in use. Any damage resulting from the use of cover removing mechanisms is not covered under warranty.

DISCLAIMERS

Arctic Spas® will not be liable for loss of use of the spa or other incidental or consequential costs, expenses or damages that may include but not limited to, the removal of a permanent sun deck, sunroom, gazebo, or other custom fixture, any crane costs associated with the removal of the spa for service or replacement. Arctic Spas® shall not be liable for costs arising from water, filter cartridges and chemical loss. Under no circumstances shall Arctic Spas® or any of its representatives be liable for any injury to any person or damage to any property, howsoever arising from the spa. Arctic Spas® warranties are limited to a maximum amount of moneys received by Arctic Spas® with respect to the sale of the spa.

ALL WARRANTIES

The warranties contained herein are all of the warranties provided by Arctic Spas® to the customer, and to the extent permitted by law. Warranty registration (within 30 days of delivery) is the responsibility of the customer and is a condition of warranty coverage. This Warranty is offered as an extra benefit and does not affect your statutory rights. All warranties herein require that any claim must be submitted to Arctic Spas® within ten days of the time the defect is discovered, and must be accompanied by the original customer's receipt confirming purchase of the spa, which shows the date of purchase. All warranty claims must be submitted within the warranty period. Failure to provide such notice and information invalidates all warranties provided hereunder. Arctic Spas® reserves the right to repair or replace components or materials at its option. In certain cases, photographs may be required for proper evaluation before warranty coverage is determined. In the event a customer is unable to either obtain parts or satisfactory service from a Factory Authorized Dealer of Arctic Spas®, notice should be given immediately to the service department of the agent where the spa was purchased and to Arctic Spas®.

Arctic Spas® expressly excludes warranty coverage on splitting, fading or warping of the cedar cabinet beyond the date of delivery. Any damage resulting from handling of the cedar cabinet is excluded from this warranty. This warranty will not cover any labour for Bluetooth connection assistance/issues, onSpa® App initialization & connection assistance/issues from a smartphone, or assistance with actually connecting any of these devices.



Core Series Spas Warranty

Spa Shell ~ 7 years

Arctic Spas® warrants the Core Series shell to the customer against water loss due to structural failure for a period of 7 years.

Equipment & Plumbing ~ 3 year parts and 1 year labour

Arctic Spas® warrants the Core Series electrical equipment components ~ specifically the pump(s) *(please refer to detailed pump warranty below), factory installed aquanova ozone system, heater (including the Tru-Guard™ Heater) and control system against malfunctions due to defects in materials and workmanship for a period of 3 years to the original purchaser from the original date of delivery. Includes parts necessary to repair. Labour is included for a period of 1 year.

Other Components ~ 3 years

Arctic Spas® warrants the Core Series fuses, lights, jet inserts, topside control overlays, cabinet material, filter baskets and weir assemblies, diverter handles, in.touch 2 internet control and caps, air control handles and caps, plastic cover clips, chrome trim and all other unmentioned components to be free of defects in workmanship and materials for a period of 3 years to the original purchaser from the original date of delivery. Includes only parts necessary to repair, not labour.

AquaNova ~ 1 year

AquaNova limited warranty one (1) year on sanitizer, check valve assembly & UV-C

Shell Surface ~ 3 years

Arctic Spas® warrants the Core Series interior surface to the customer against water loss due to material failure including cracks, blisters, peeling and delaminating for a period of 3 years to the original purchaser from the original date of delivery. Includes parts and labour necessary to repair.

Vacseal Cover (4"-2") ~ 1 year

Arctic Spas® warrants the standard Core Series cover against malfunctions due to defects in materials and workmanship for one year to the original owner from the original date of delivery. Includes parts necessary to repair.

Upgraded Vacseal Cover (5"-4") ~ 3 yrs

Arctic Spas® warrants the upgraded VACSEAL™ cover against malfunctions due to defects in materials and workmanship for three years to the original owner from the original date of delivery. Includes parts necessary to repair. (Normal wear and tear is not included in this warranty, when used with a cover lifter seam damage will be considered normal wear and tear.

Core Sound ~ 1 year

Arctic Spas® warrants the factory installed essential sound stereo system against malfunction due to defects in materials and workmanship for one year to the original customer from original customer from original delivery. Includes parts and onsite labour necessary to repair.

Everlast Floor ~ 3 years

Arctic Spas® warrants the Everlast Floor against structure cracking for a period of 3 years to the original customer from the original date of delivery. Includes parts necessary to repair.

Arctic Spas® extends this limited warranty solely to the original customer of any Arctic self-contained spa installed by an approved Arctic Spas Dealer, for 3 years of delivery date or 4 years from manufacture ship date whichever ever comes first to the original purchaser of the spa.

DETAILED PUMP WARRANTY

Pump(s) are warranted against material and component failure. The pump shaft seal is covered under warranty. Damage resulting from a neglected leaking shaft seal is not covered under warranty. This includes but is not limited to bearing seizure, end bell failure, start switch failure, impeller failure and capacitor failure. It is the responsibility of the customer to report shaft seal failure before further damage can occur. Any pump component failure determined to be the result of defective material will be replaced under warranty. Arctic Spas® reserves the right to replace pump components, rather than the complete pump assembly. Vibration noise associated with normal pump operation is excluded under this warranty.

PERFORMANCE

To obtain service in the event of a defect or malfunction covered by this Limited Warranty, notify your Arctic Spa dealer as soon as possible and use all reasonable means to protect the spa from further damage. Upon proof of purchase, Arctic Spas® agent or its designated service representative will correct the defect subject to the terms and conditions continued in this Limited Warranty. Pre-Approved claims must be executed within 60 days of Pre-approval, All existing claims expire upon expiration of warranty. *Please note that union connection leaks are considered to be user serviceable and are expressly excluded from the Limited Warranty. Damage resulting from union connection leaks are expressly excluded from the Limited Warranty. There will be no charge for on site labour to the customer for a period of one year from the date of original delivery or 2 years from manufacturer's ship date, whichever comes first. Specifically equipment, plumbing and shell surfaces against malfunctions due to any defect in the material and workmanship within the Limited Warranty. Travel costs are the responsibility of the customer. Your limited warranty will cover a maximum of \$60 towards on site labor per each approved warranty claim. Service and/or travel costs are covered within the first 30 days of ownership to a maximum distance of 100KM from dealership or designated service outlet. If Arctic Spas® determines that repair of the covered defect is not feasible we reserve the right to instead provide a replacement spa equal in value to the original purchase price of the defective spa. Spa replacement is done only at the discretion of Arctic Spas®. Reasonable costs for the removal of the defective spa, and delivery and installation will be the responsibility of the spa customer. Freight will be paid to the nearest Arctic Spas® distribution centre.

CONDITIONS OF WARRANTIES

All warranties provided hereunder extend only to the original customer of the spa if purchased by an authorized Arctic Spas dealer and originally installed within the boundaries of the country where it was originally purchased. All warranties hereunder terminate upon transfer of ownership of a spa from the original customer. This warranty only applies within the service area where the spa was originally installed. Your limited warranty does not include repair travel mileage or for shipping cost assessed by your Factory Authorized Dealer or service agents. All events covered by this Limited Warranty hereunder must be repaired by a Factory Authorized Dealer of Arctic Spas®. The warranties will not include any costs of repair incurred by a non-factory authorized agent. To obtain service, the customer must contact the Factory Authorized Dealer in his area. In the event that a spa or component thereof must be returned to Arctic Spas® distribution center, all freight costs are the responsibility of the spa customer. After 30 days from delivery, a deductible or "excess" fee will be applied to all warranty costs. This fee will be a maximum of \$75 CAD or equivalent local currency, and may be applied to the parts or labour component costs associated with each separate job covered by the warranty. Charges not covered by the warranty or after the warranty period expires are not affected by this condition. To obtain this Limited Warranty hereunder the spa must be purchased from a Factory Authorized Dealer of Arctic Spas®.



Core Series Spas Warranty (continued)

EXCLUSIONS

All warranties hereunder are void if the spa has been subject to alterations (including after-market accessories), misuse or abuse or any repair of the spa has been attempted by anyone other than a Factory Authorized Dealer of Arctic Spas®. Alterations include but not limited to, any change to the components, replacement of components or addition of components without the written authorization from Arctic Spas®. Misuse includes careless handling of the spa, damages caused by improper and/or non-certified electrical hook-ups, failure to operate the spa in accordance with the instructions contained in the owner's manual provided with the spa, including incorrect start-up procedures or dry firing of the spa, any use of the spa or any of its components in an application for which it was not designed, and damage caused by improper chemical balance (including any damage to spa components caused by scale build up to due to poor water chemistry), ice in the spa, overheating the spa or spa water, damage to the spa surface by allowing undissolved sanitizing chemicals to lie on the surface or if our spa has been used for commercial purposes. Spa covers are not warranted against chemical burn or discolouration. Spa covers are not warranted against water absorption or any damage resulting from water absorption. Any damage resulting from the mishandling of the spa cover in any way is not covered under warranty. Any damage caused by moving of the spa or improper installation (including insufficiently prepared or uneven ground) is considered abuse and any damage to the material or workmanship of the spa cabinetry and floor in shipping or handling are expressly excluded from the Limited Warranty.

Arctic Spas will not be responsible for power company issues or improper electrical installations, Damage and/or lack of performance resulting from high or low voltages outside operating parameters. Arctic Spas will not be responsible for software and product upgrades throughout the life of the spa.

Arctic Spas® expressly excludes warranty coverage on any of the following: Acts of nature including but not limited to damage resulting from lightning, storm, flooding, freezing, fire and any other acts of nature. Any spa installed in a commercial application. Any failure caused by improper cover use or or damage to the spa surface by leaving the spa outdoors without the hot tub cover in place. The heat created by leaving the spa in direct UV light without a cover may cause surface issues with the acrylic and may also cause plastic parts to warp, some fittings will leak or cease working as a result. These occurrences are not covered under warranty. The hot tub cover must be kept on the hot tub when not being used.

Scratches or micro-crazing in the spa shell reported after the day of installation are not covered under warranty. Micro-crazing is defined as an area of tiny shiny lines visible in areas on the surface of some thermoplastic sheets. This phenomena, although rare, is known to occur in many types of plastic sheet materials. The surfaces of thermoformed acrylic hot tubs are not immune to this possibility.

Damaged caused by unapproved sanitizers such as tri-chlor, acids, calcium hypochlorite, sodium hypochlorite, peroxides, any sanitizing chemical that may remain undissolved on the spa surface. **Any and all sanitation systems or chemicals used in your spa must be factory approved by Arctic Spas or your**

warranty is void. You can check for a list of approved systems and chemicals at arctic spas.com. Installation of not factory approved systems will void the warranty related to pump seals, metal part, jets, etc. Damage caused by any item(s) attached to or installed onto the spa, including but not limited to gazebos, cover lifters and cedar accessories. Any options or additional components that are not factory installed are not covered under warranty. Any damage or failure due to improper preparation for winter storage is not covered under warranty. Damage to pillows reported beyond the day of delivery will not be covered under warranty. Pillows are to be removed from the spa when not in use. Any damage resulting from the use of cover removing mechanisms is not covered under warranty.

DISCLAIMERS

Arctic Spas® will not be liable for loss of use of the spa or other incidental or consequential costs, expenses or damages that may include but not limited to, the removal of a permanent sun deck, sunroom, gazebo, or other custom fixture, any crane costs associated with the removal of the spa for service or replacement. Arctic Spas® shall not be liable for costs arising from water, filter cartridges and chemical loss. Under no circumstances shall Arctic Spas® or any of its representatives be liable for any injury to any person or damage to any property, howsoever arising from the spa. Arctic Spas® warranties are limited to a maximum amount of moneys received by Arctic Spas® with respect to the sale of the spa.

ALL WARRANTIES

The warranties contained herein are all of the warranties provided by Arctic Spas® to the customer, and to the extent permitted by law. Warranty registration (within 30 days of delivery) is the responsibility of the customer and is a condition of warranty coverage. This Warranty is offered as an extra benefit and does not affect your statutory rights. All warranties herein require that any claim must be submitted to Arctic Spas® within ten days of the time the defect is discovered, and must be accompanied by the original customer's receipt confirming purchase of the spa, which shows the date of purchase. All warranty claims must be submitted within the warranty period. Failure to provide such notice and information invalidates all warranties provided hereunder. Arctic Spas® reserves the right to repair or replace components or materials at its option. In certain cases, photographs may be required for proper evaluation before warranty coverage is determined. In the event a customer is unable to either obtain parts or satisfactory service from a Factory Authorized Dealer of Arctic Spas®, notice should be given immediately to the service department of the agent where the spa was purchased and to Arctic Spas®.

Arctic Spas® expressly excludes warranty coverage on splitting, fading or warping of the cabinet beyond the date of delivery. Any damage resulting from handling of the cabinet is excluded from this warranty. This warranty will not cover any labour for Bluetooth connection assistance/issues, In.touch 2 Internet Control initialization & connection assistance/issues from a smartphone, or assistance with actually connecting any of these devices.

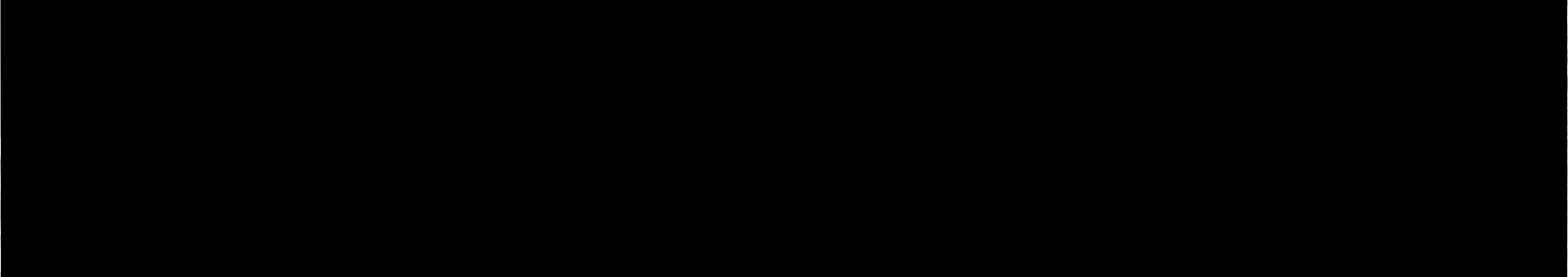

engineered for the world's harshest climates®

#201906